

XCite™ Advanced Programming & Configuration

XCite Product Family
Modes of Operation
Radio Modem Configuration
Advanced Networking & Security
Appendices



Advanced Manual v1.1

Advanced Development for the XCite Product Family

Products Supported: XCite OEM RF Modules (900 MHz)
 XCite RS-232/485 and USB RF Modems



355 South 520 West, Suite 180
Lindon, UT 84042
Phone: (801) 765-9885
Fax: (801) 765-9895

rf-xperts@maxstream.net
www.maxstream.net

Secure online ordering 24/7/365 from **B & B electronics**
MANUFACTURING COMPANY
International Headquarters: 707 Dayton Road P.O. Box 1040 Ottawa, IL 61350 USA
815-433-5100 Fax 433-5104 www.bb-elec.com orders@bb-elec.com support@bb-elec.com
European Headquarters: Westlink Commercial Park Oranmore Co. Galway Ireland
+353 91 792444 Fax +353 91 792445 www.bb-europe.com orders@bb-elec.com support@bb-europe.com

M100045
2005.08.02

© 2005 MaxStream, Inc. All rights reserved

No part of the contents of this manual may be transmitted or reproduced in any form or by any means without the written permission of MaxStream, Inc.

XCite™ is a trademark of MaxStream, Inc.

Technical Support

Phone: (801) 765-9885

Live Chat: www.maxstream.net

E-Mail: rf-xperts@maxstream.net

Contents

XCite Product Family	5
Introduction	5
Pin Signals	6
I/O Pin Signals	8
Flow Control Pin Signals	9
Remaining Pin Signals	10
Interfacing Hardware	11
XCite Development Kit (RS-232/485)	11
MaxStream RS-232/485 Interface Board (Part Number: XIB-R)	11
RS-232/485 Interface Board Components & Features	12
Adapters	13
Antennas	15
Modes of Operation	16
Idle Mode	16
Transmit Mode	17
Cyclic Redundancy Check (CRC)	17
Transmission Latency	17
Receive Mode	18
Sleep Modes	19
Pin Sleep (SM = 1)	19
Serial Port Sleep (SM = 2)	20
Cyclic Sleep (SM = 3-8)	20
Cyclic Scanning	21
AT Command Mode	22
AT Command Mode Protocol	22
Configuration Software	24
X-CTU Software	24
Serial Communications Software (for AT Commands Only)	24
Radio Modem Configuration	25
Command & Parameter Types	25
AT Commands	25
Non-AT Settable Parameters	25
XCite Command & Parameter Reference	26
Individual Command & Parameter Descriptions	27
Advanced Networking and Security	37
Network Layers	37
Vendor Identification Number (ATID)	38
Channel (ATHP)	38
Destination Address (ATDT) and Address Mask (ATMK)	38

Appendix A: FCC Certifications	41
<hr/>	
FCC Compliance 41	
OEM Labeling Requirements 41	
FCC Notices 42	
9XCite (900 MHz) Approved Antennas 43	
Appendix B: Additional Information	44
<hr/>	
XCite OEM RF Module Specifications 44	
1-Year Warranty 45	
XCite OEM RF Module Part Numbers 45	
Appendix C: Troubleshooting & FAQs	46
<hr/>	
Contact MaxStream 46	

XCite Product Family

Introduction

The XCite Radio Modem is a drop-in wireless solution that can add RF connectivity to any data system. XCite Radio Modems transfer a standard asynchronous serial data stream and feature the following:

- Continuous data stream of up to 38400 bps (factory-set, RF data rate)
- Serial Interfacing from 1200 to 115200 bps
- Software selectable between Hopping (FHSS) and Single Frequency Channel Modes
- Approved by the FCC under Part 15 of the FCC Rules and Regulations
- Variable input supply voltage (2.85 – 5.50 VDC)

This advanced manual provides information on how to operate and configure XCite Radio Modems to accommodate a wide range of design criteria. Modems can be configured to activate advanced functionality in networking, serial interfacing, sleep (low power) modes and diagnostics.

Features:

Long Range

- Indoor/Urban Range: **Up to 300'** (90 m)
- Outdoor/RF Line-of-sight Range: **Up to 1000'** (300 m)
- Receiver Sensitivity: **-108 dBm** (9600 Baud), **-104 dBm** (38400 Baud)

Low Power

- Transmit Power Output: **4 mW** [50 mW effective considering receiver sensitivity]
- **55 mA** transmit / **45 mA** receive current consumption
- Power-down current as low as **20 µA**

Advanced Networking & Security

Specifications [[Appendix B](#)]

1-Year Warranty [[Appendix B](#)]

Free & Unlimited Technical Support [[Appendix C](#)]

Worldwide Acceptance

FCC Approved (USA) [Go to [Appendix A](#) for FCC Requirements]

Devices that embed XCite Radio Modems can inherit MaxStream's FCC certification

IC (Industry Canada) Certified

ISM (Industrial, Scientific & Medical) frequency band

MaxStream products manufactured under **ISO 9001:2000** registered standards



Pin Signals

The interface signals are available through an 11-pin header. All pins operate on 2.85-5.50V CMOS levels. The following five J1 pin signals are most commonly used in data radio systems:

- DI (pin 4 – Data In)
- DO (pin 3 – Data Out)
- VCC (pin 10 – Power)
- GND (pin 11 – Ground)
- DO2- $\overline{\text{CTS}}$ (pin 1 – Clear-to-Send)

Application Circuit

Figure 1. Application Circuit – connection to host processor

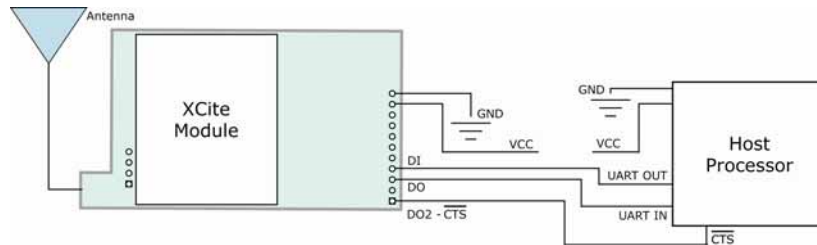

Table 1. J1 Pin Descriptions – XCite OEM RF Module pin signals and their functions

(Low-asserted signals distinguished with a horizontal line over signal name)

Module Pin	Signal Name	I/O	When Active	Description
1	DO2	O*	low	Clear-to-Send ($\overline{\text{CTS}}$) Flow Control
2	DI3	I*	high	Can be used to enter Sleep Modes that consume less power
3	DO (Data Out)	O*	n/a	Serial Data leaving the XCite Module (to the host)
4	DI (Data In)	I	n/a	Serial data entering the XCite Module (from the host)
5	DI2	I**	low	Request-to-Send ($\overline{\text{RTS}}$)
6	$\overline{\text{RESET}}$	I*	low	Reset Module Parameters
7	DO3	O	high	Receive (RX) LED
8	$\overline{\text{TX}}$ / PWR	O	low	$\overline{\text{TX}}$ - Asserted during transmission
			high	PWR - Indicates power is on
9	$\overline{\text{CONFIG}}$	I***	low	Backup method for entering AT Command Mode. Primary method is with "+++" [See CC Parameter]
10	VCC	I	-	2.85 – 5.50 VDC Regulated
11	GND	-	-	Ground

* Pin utilizes 10K Ω Pull-Up resistor (already installed in the module)

** Pin utilizes 10K Ω Pull-Down resistor (already installed in the module)

*** Pin utilizes 100K Ω Pull-Up resistor (already installed in the module)

Note: When integrating the XCite Module onto a Host PC Board, all lines that are not used should be left disconnected (floating).

Table 2. J2 Pin Descriptions

Module Pin	Pin Name
1	Reserved
2	GND
3	GND
4	GND

J2 Pins are used primarily for mechanical stability and may be left disconnected.

I/O Pin Signals

● Pin 4: DI (Data In)

<Input> Data enters the XCite Module through the DI Pin as an asynchronous serial signal. The signal should idle high when no data is being transmitted.

Each data packet consists of a start bit (low), 8 data bits (least significant bit first) and a stop bit (high). The figure of a UART data packet [Figure 2] illustrates the serial bit pattern of data shifting into the module. The start and stop bits from the UART signal are not transmitted, but are regenerated on the receiving module.

→ DI Buffer

Once serial data has entered the XCite Module through the DI Pin, the data is stored in the DI Buffer until it can be transmitted.

Once the first byte of data enters the DI Buffer, the module begins to initialize the RF channel unless RF data is already being received. In the case where the module is receiving RF data, serial data is stored in the DI Buffer. When the DI Buffer is 17 bytes away from being full, the XCite Module de-asserts (high) \overline{CTS} to signal to the host device to stop sending data. \overline{CTS} re-asserts once the DI Buffer has at least 35 bytes available.

In addition to \overline{CTS} hardware flow control, XON/XOFF software flow control can also be implemented [See the FL (Software Flow Control) Command]. In this case, the XCite Module sends XON and XOFF signals in addition to asserting/de-asserting \overline{CTS} .

Figure 2. UART data packet 0x1F (decimal number “31”) as transmitted through the XCite Module

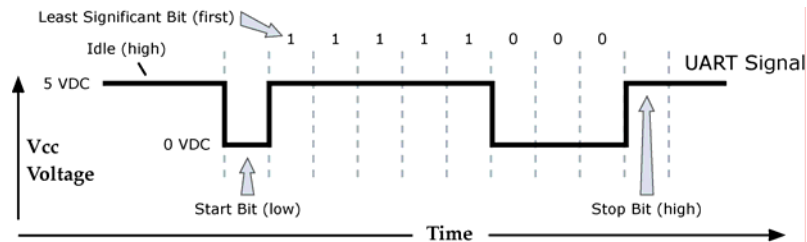

Data is packetized for transmission. The packet structure is as follows:

Figure 3. RF Packet Structure

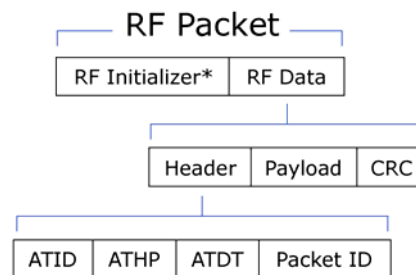

● Pin 3: DO (Data Out)

<Output> Data from RF (over-the-air) transmission is received through the DO Pin. Received data is checked for errors and addressing, then sent to the DO Buffer before being sent to the host device. This pin utilizes a 10K Ω Pull-Up resistor that is already installed in the module.

DO Buffer →

Once incoming RF data is received into the DO Buffer, data is sent out the serial port to a host device. If \overline{RTS} is enabled for flow control, data will not be sent out the DO Buffer as long as the \overline{RTS} pin is de-asserted (high). In such a scenario, data could be lost if \overline{RTS} is de-asserted long enough to allow the DO Buffer to become full. Pins 1 & 2 can also be used for flow control.

Flow Control Pin Signals

● Pin 1: DO2- $\overline{\text{CTS}}$ (Clear-to-Send)

<Output> The $\overline{\text{CTS}}$ pin (Clear-to-Send) informs the host device whether or not serial data can be sent to the XCite Module from the host device. When Pin 1 is asserted (low), serial data is permitted to be sent to the XCite Module. In RS-232 applications, Pin 1 is directly associated with the DI Buffer. In RS-485/422 applications, the Pin 1 signal controls the transmit driver (TX enable) on the RS-485 and RS-422 logic converters (on the MaxStream Interface Board or equivalent). Pin 3 utilizes a 10K Ω Pull-Up resistor that is already installed in the module. In some applications, Pin 1 may not need to be observed.

$\overline{\text{CTS}}$ Hardware Flow Control

If the DI Buffer reaches its capacity, either the $\overline{\text{CTS}}$ line or XON / XOFF flow control must be observed to prevent loss of data between the host device and the XCite Module. There are two cases in which the DI Buffer may become full:

1. If the serial interface rate is set higher than the default baud rate for the module, the module will receive serial data faster than it is transmitted.
2. If the XCite Module is receiving a continuous stream of data or if it is monitoring data on a network, any serial data that arrives on the DI pin is placed in the DI Buffer. This data will be transmitted when the module no longer detects RF data in the network.

XON Software Flow Control

XON/XOFF software flow control can be used (on Pin 3) instead of $\overline{\text{CTS}}$ hardware flow control. [See FL (Software Flow Control) Command for more information]

● Pin 5: DI2- $\overline{\text{RTS}}$ (Request-to-Send)

<Input> The Pin 5 ($\overline{\text{RTS}}$) signal can be configured to enable $\overline{\text{RTS}}$ flow control recognition. Use RT Command to adjust the parameters that control Pin 5 flow control. By default, $\overline{\text{RTS}}$ flow control is not observed. This pin utilizes a 10K Ω Pull-Down resistor already installed in the module.

$\overline{\text{RTS}}$ Hardware Flow Control

If $\overline{\text{RTS}}$ flow control is enabled, no data is sent out the DO pin when $\overline{\text{RTS}}$ is de-asserted (high). If $\overline{\text{RTS}}$ flow control is implemented on the host device, RT Parameter must be set on the XCite Module in order to recognize the $\overline{\text{RTS}}$ signal as a flow control line.

If $\overline{\text{RTS}}$ is asserted (low), all received RF data is placed in the DO Buffer until the line is de-asserted. Once the DO Buffer reaches capacity, any additional received RF data is lost.

XOFF Software Flow Control

XON/XOFF software flow control can be used (on Pin 4) to simulate $\overline{\text{RTS}}$ hardware flow control. [See FL (Software Flow Control) Command for more information]

Remaining Pin Signals

● Pin 2: DI3-Sleep/Power-Down

<Input> Pin 2 can be used to transition the XCite Module into a low power-consuming Sleep Mode. If SM = 1 [SM (Sleep Mode) Command], allowing Pin 2 to float high causes the module to enter into a state of minimal power-consumption (until awakened by driving Pin 2 low). [Go to the "Sleep Modes" section for more information.] This pin utilizes a 10K Ω Pull-Up resistor already installed in the module.

● Pin 6: $\overline{\text{RESET}}$

<Input> Pin 6 is almost always high and only low when the radio is reset. Since the OEM module has an onboard reset monitor, this pin can be left disconnected. Pin 6 utilizes a 10K Ω Pull-Up resistor already installed in the module.

● Pin 7: DO3-RX LED

<Output> Pin 7 is normally driven low, but is driven high briefly by the radio to indicate RF data reception. This pin can be tied through a resistor to an LED for visual indication.

● Pin 8: $\overline{\text{TX}}$ / PWR

<Output> Pin 8 is normally driven high and can be tied through a resistor to an LED to indicate the following:

- The module has power
- The module is not in sleep mode
- Pin 8 pulses on/off when data is transmitted over-the-air.

● Pin 9: $\overline{\text{CONFIG}}$

<Input> When Command Mode cannot be entered using normal procedure [See "Command Mode" section], the $\overline{\text{CONFIG}}$ pin is used to manually enter the module into Command Mode. If Pin 9 is asserted during reset or power-up, the module immediately enters into Command Mode at the module's default baud rate. After the pin is asserted, the serial port baud rate is temporarily set to match the default baud rate of the XCite Module in use. Upon entering into Command Mode, all configured parameters (including baud rate) remain in their saved state unless modified as is described in the "Module Configurations" chapter of this manual. This pin utilizes a 100K Ω Pull-Up resistor already installed in the module.

IMPORTANT: The $\overline{\text{CONFIG}}$ pin is intended as a secondary method for entering Command Mode. The primary method is with a command break sequence. MaxStream reserves the right to change the functionality of the $\overline{\text{CONFIG}}$ pin and recommends using the command break sequence [See "Command Mode" section] for entering Command Mode.

● Pin 10: VCC (power)

<Input> Pin 10 accepts regulated 5V signals.

● Pin 11: GND (Ground)

Pin 11 is used for grounding.

Interfacing Hardware

MaxStream, Inc. developed proprietary interface boards (MaxStream Product numbers: XIB-R for RS-232/485 interfacing) to facilitate the connection between XCite Radio Modems and serial devices. Many integrators develop their own interfacing circuitry; others use MaxStream's Interface Boards. In either case, the following sections illustrate how to interface with XCite OEM RF Modules by illustrating properties of the MaxStream XIB-R Interface Board.

XCite Development Kit (RS-232/485)

The MaxStream Interface board is included with the XCite Development Kit. The kit includes all the hardware and software needed for basic wireless connections.

Table 3. XCite Development Kit contents

Item	Qty.	Description	Part Number
Quick Start Guide	1	Quickly familiarize users with some of the XCite Module's most important functions. The guide provides step-by-step instructions on how to make an RF link and test its ability to transport data over varying ranges and conditions.	MD0009
CD	1	CD includes documentation and configuration software	M100105
XCite Module (w/ RPSMA antenna port)	1	Module comes with fixed RF Data (baud) rates up to 38400 bps	XC09 - (...) NSC
XCite Module (w/ attached wire antenna)	1	Module comes with fixed RF Data (baud) rates up to 38400 bps	XC09 - (...) WNC
MaxStream Interface Board	2	Supplies regulated 5V DC power to module and provides signal-level conversion for interfacing with PC RS-232 serial ports or RS-485/422 devices	XIB-R
RPSMA Antenna	1	RPSMA half-wave dipole antenna	A09-HASM-675
Serial Loopback Adapter	1	Connects to the female RS-232 (DB-9) serial connector of the XCite Module and can be used to configure the radio modem to function as a repeater (for range testing)	JD2D3-CDL-A
NULL Modem Adapter (male-to-male)	1	Connects to the female RS-232 (DB-9) serial connector of the XCite Module and can be used to connect the radio modem to another DCE (female DB9) device	JD2D2-CDN-A
NULL Modem Adapter (female-to-female)	1	Used to bypass radios to verify serial cabling is functioning properly	JD3D3-CDN-A
Male DB-9 to RJ-45 Adapter	1	Facilitates adapting the DB-9 Connector to a CAT5 cable (female RJ45 to male DB9)	JE1D2-CDA-A
Female DB-9 to RJ-45 Adapter	1	Facilitates adapting the DB-9 Connector to a CAT5 cable (female RJ45 to female DB9)	JE1D3-CDA-A
9V AC Power Adapter	2	Wall-based transformer with US 2-prong plug	JP4P2-9V4-6F
9V Battery Clip	1	Allows Interface Board to be remotely powered by a 9V battery	JP2P3-C2C-4I
RS-232 Cable (6')	2	Straight-through serial cable that connects interface board (DCE) to a PC (DTE)	JD2D3-CDS-6F

MaxStream RS-232/485 Interface Board (Part Number: XIB-R)

The MaxStream Interface board was developed to provide a means of connecting the XCite Module to any system having an RS-232 or RS-485/422 connection. Since the XCite Module requires signals to enter at CMOS voltages, one of the main functions of the interface board is to convert interface signals from CMOS levels (2.85 – 5.50V) to RS-232 levels (-12 - +12V). The MaxStream Interface Board includes the following built-in features:

- DIP Switch
- Configuration Switch
- Power Switch
- LEDs
- DB-9 Connector
- Power Connector

RS-232/485 Interface Board Components & Features

Figure 4. Front View

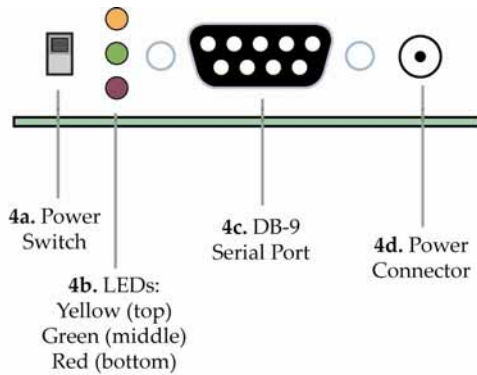

4a. Power Switch

Move the Power Switch to the on (up) position to power the Interface Board. DIP Switch [5a] settings are only read during a power-up sequence.

4b. LEDs

The LED indicators visualize diagnostic status information. The radio modem's status is represented as follows:

- **Yellow** (top LED) = Serial Data Out (to host)
- **Green** (middle) = Serial Data In (from host)
- **Red** (bottom) = Power/TX Indicator (Red light is on when powered, off briefly during RF transmission)

4c. Serial Port

Standard female DB-9 (RS-232) DCE connector – This connector can be also used for RS-485 and RS-422 connections.

4d. Power Connector

7-18 VDC Power Connector (Center positive, 5.5/2.1mm) – Power can also be supplied through Pin 9 of the DB-9 Connector.

Figure 5. Back View

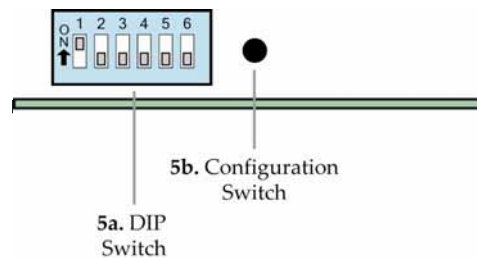

5a. DIP Switch

The DIP Switch configures the XCite OEM RF Module to operate in different modes. DIP Switch settings are only read and applied during a powering-on sequence. [See Figure below for DIP Switch settings]

5b. Configuration Switch

The Configuration Switch provides an alternate way to enter "AT Command Mode". To enter "AT Command Mode" at the radio modem's default baud rate, hold the Configuration Switch down while powering on the module using the Power Switch.

Figure 6. MaxStream XIB-R (RS-232/485) Interface Board DIP Switch Settings

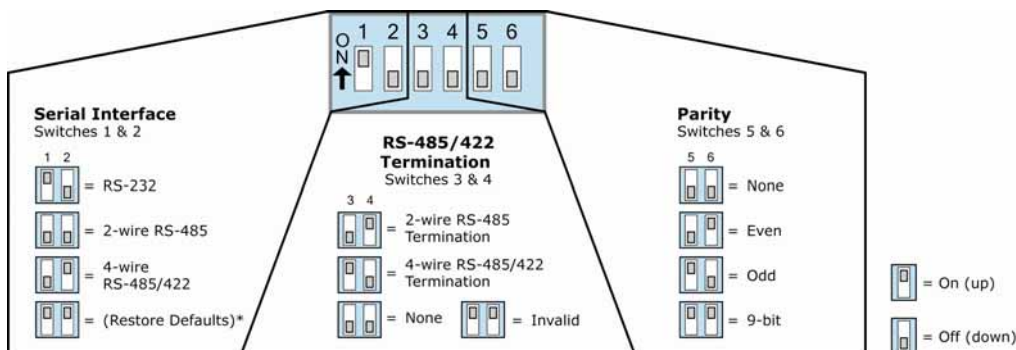

* The "(Restore Defaults)" setting, for switches 1 & 2, can be used to restore AT Settable parameters to their default states. Once switches are in position, reset occurs during next power-up.

Adapters

The MaxStream Development Kit comes with several adapters. The connectors and adapters facilitate basic functions, such as the following:

- Performing Range Tests
- Testing Cables
- Connecting to other RS-232 DCE or DTE devices
- Connecting to terminal blocks or RJ-45 for RS-485/422 devices

NULL Modem Adapter (male-to-male)

Part Number: JD2D2-CDN-A (Black, DB-9 M-M) The male-to-male NULL modem adapter can be used to connect two DCE devices. A DCE device is one that connects with a straight-through cable to the male serial port of a computer (DTE).

Figure 7. Male NULL modem adapter and pinouts

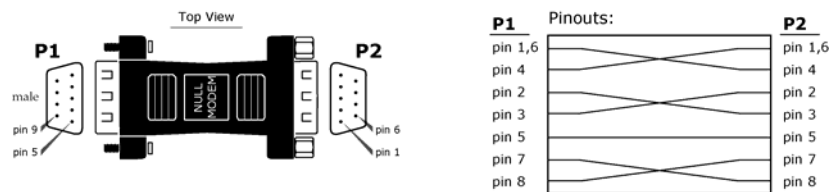

NULL Modem Adapter (female-to-female)

Part Number: JD3D3-CDN-A (Gray, DB-9 F-F) The female-to-female NULL modem adapter can be used to verify serial cabling is functioning properly. To test cables, insert the female-to-female NULL modem adapter in place of a pair of radio modems and test the connection without radio modules in the connection.

Figure 8. Female NULL modem adapter and pinouts

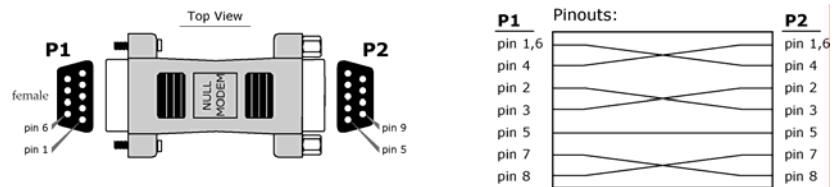

Serial Loopback Adapter

Part Number: JD2D3-CDL-A (Red, DB-9 M-F) The serial loopback adapter is used for range testing. During a range test, the serial loopback adapter configures the radio modem to function as a repeater by looping serial data back into the radio for retransmission.

Figure 9. Serial loopback adapter and pinouts

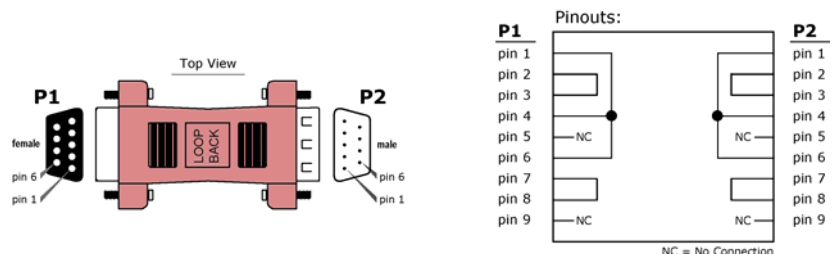

Male DB-9 to RJ-45 Adapter

Part Number: JE1D2-CDA-A (Yellow, RJ-45 female to DB-9 male) This adapter facilitates adapting a DB-9 connector to a CAT5 cable.

Figure 10. Male RS-485/422 Adapter and pin specifications

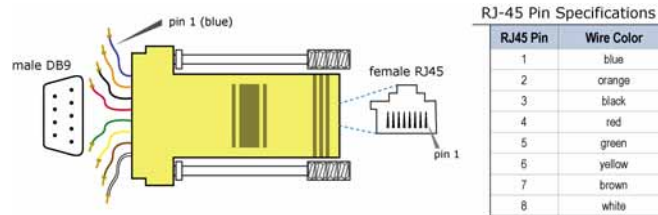

Female DB-9 to RJ-45 Adapter

Part Number: JE1D3-CDA-A (Green, RJ-45 female to DB-9 female) This adapter facilitates adapting a DB-9 connector to a CAT5 cable.

Figure 11. Female RS-485/422 Adapter and pin specifications

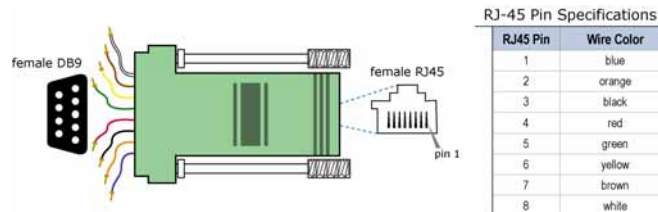

RS-485/422 Connection Guidelines

The RS-485/422 protocol provides a solution for wired communications that can tolerate high noise and push signals over long distances. RS-485/422 signals can communicate as far as 4000 feet (1200 meters). RS-232 signals are only suitable for cable distances up to 100 feet (30.5 meters).

RS-485 offers multidrop capability in which up to 32 nodes can be connected. The RS-422 protocol is used for point-to-point communications.

Suggestions for integrating the XCite Module with the RS-485/422 protocol:

1. When using Ethernet twisted pair cabling: Select wires so that T+ and T- are connected to each wire in a twisted pair. Likewise, select wires so that R+ and R- are connected to a twisted pair. (For example, tie the green and white/green wires to T+ and T-.)
2. For straight-through Ethernet cable (not cross-over cable) – The following wiring pattern works well: Pin 3 to T+, Pin 4 to R+, Pin 5 to R-, Pin 6 to T-
3. Note that the connecting cable only requires 4 wires (even though there are 8 wires).
4. When using phone cabling (RJ-11) – Pin 2 in the cable maps to Pin 3 on opposite end of cable and Pin 1 maps to Pin 4 respectively.

Antennas

[See Appendix A for a list of FCC-Approved Antennas]

Factors that determine the distance an RF link can transmit:

- Ambient RF noise (interference)
- Line-of-sight obstructions
- Transmit power
- Receive sensitivity
- Antenna configuration

Factors that affect antenna performance:

- RF cable length
- Height of antennas off the ground
- Obstructions
- Radiation pattern
- Antenna Gain

XCite Antenna Connector Options

In order to comply with the FCC rules and obtain a “modular” certification, it is required that the XCite Modules utilize a “non standard” connector. This is to ensure that the radios are used only with approved antennas. The XCite radio modules have two connector options:

- RPSMA
- N-Connector

RPSMA

The Reverse Polarity SMA (RPSMA) connector uses the same body as a regular SMA connector. In order to be a “non standard” connector, the gender of the center conductor is changed. A female RPSMA will actually have a male center conductor.



N-Connector

An N-Connector does not come installed on the XCite Modules, but is a common connector used with higher gain antennas. MaxStream can supply “RPSMA to N-Connector” cables in various lengths.

Antenna Cables

RF cables are typically used to connect a radio installed in a cabinet to an antenna mounted externally. As a general rule, it is best to keep the RF cable as short as possible. All cables have losses which are usually measured in dB loss per 100 ft. MaxStream has cables available made with LMR-195. Some common cables and dB losses are included in this table:

Table 4. Potential Signal Strength Loss due to Antenna Cable Length

Cable Type	Loss at 900 MHz per 100' (loss per 100m)	Loss at 2.4 GHz per 100' (loss per 100m)	Diameter Inches (mm)
RG-58	14.5 dB (47.4 dB)	25.3 dB (83.2 dB)	0.195" (5.0 mm)
RG-174	25.9 dB (85.0 dB)	44.4 dB (145.8 dB)	0.100" (2.5 mm)
RG-316	24.7 dB (81.0 dB)	42.4 dB (139.0 dB)	0.102" (2.6 mm)
LMR-195	11.1 dB (36.5 dB)	19.0 dB (62.4 dB)	0.195" (5.0 mm)
LMR-240	7.6 dB (24.8 dB)	12.9 dB (42.4 dB)	0.240" (6.1 mm)

Modes of Operation

XCite Radio Modems operate in five modes. The modules operate in one mode at a time.

Figure 12. MaxStream Modes of Operation

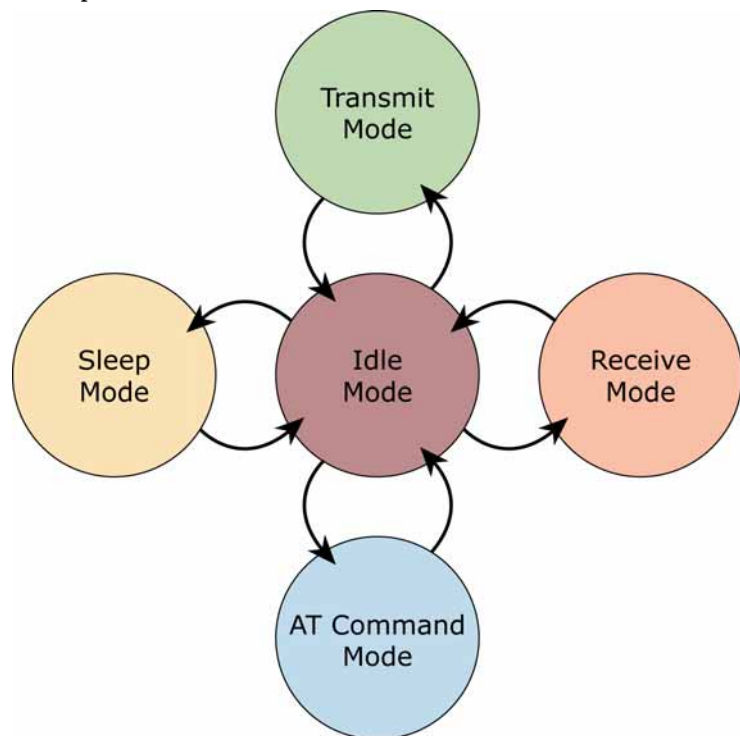

Idle Mode

XCite Modules operate in Idle Mode when data is not being transmitted nor received. While in Idle Mode, modules use the same amount of power as they do in RX (Receive) mode. Modules will transition into other modes under any of the following conditions:

1. Serial data is received in the DI Buffer (Module then transitions into Transmit Mode)
2. Valid data is received by the antenna (Module then transitions into Receive Mode)
3. AT Command Mode Sequence is issued (Module then transitions into AT Command Mode)
4. Sleep Mode condition is met (Module then transitions into Sleep Mode)

Modules automatically transition back to Idle Mode once finished responding to these conditions.

Transmit Mode

When the first byte of serial data comes through the DI Pin and arrives in the DI Buffer, the module transitions into Transmit Mode. Once in Transmit Mode, the module initializes a communications channel. During channel initialization, incoming serial data accumulates in the DI buffer. After the channel is initialized, data in the DI buffer is grouped into packets (up to 64 bytes in each packet) and is transmitted. The module continues to transmit data packets until the DI buffer is empty. Once transmission is finished, the module returns to Idle Mode. This progression is shown below:

Figure 13. Transmission of data

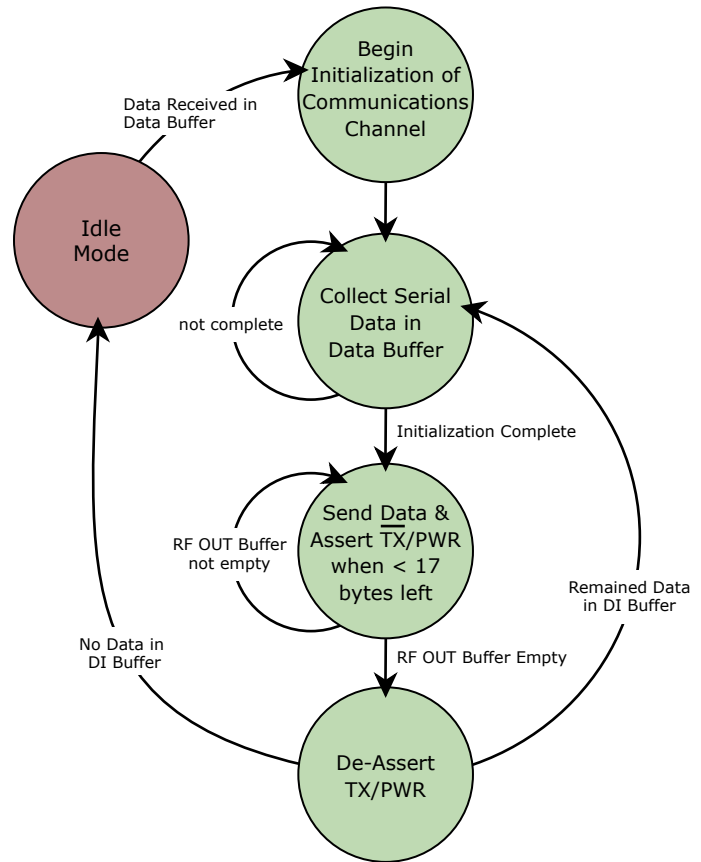

(A Block Diagram of the XCite Module is located in the "XCite OEM RF Module" Product Manual)

Cyclic Redundancy Check (CRC)

To verify data integrity and provide built-in error checking, a 16-bit cyclic redundancy check (CRC) is computed for the transmitted data and attached to the end of each data packet before transmission. On the receiving end, the receiver computes the CRC on all incoming data. Received data that has an invalid CRC is discarded [See "Receive Mode" section on next page].

Transmission Latency

Transmission latency depends on the number of bytes contained in a packet and the baud rate of the module. To reduce latency in the XCite Module, load in a single channel version using the X-CTU Software. Operating in Single Frequency Channel Mode greatly reduces latency.

Receive Mode

If a module detects RF transmitted data while operating in Idle Mode, it transitions into Receive Mode to start receiving packets. Once a packet is received, it goes through the receiving-end of a CRC (cyclic redundancy check) to ensure that the data was transmitted without error. If the CRC data bits on the incoming packet are invalid, the packet is discarded. If the CRC is valid, the packet is placed the DO Buffer. This process is shown in the figure below:

Figure 14. Receive Mode Data Flow

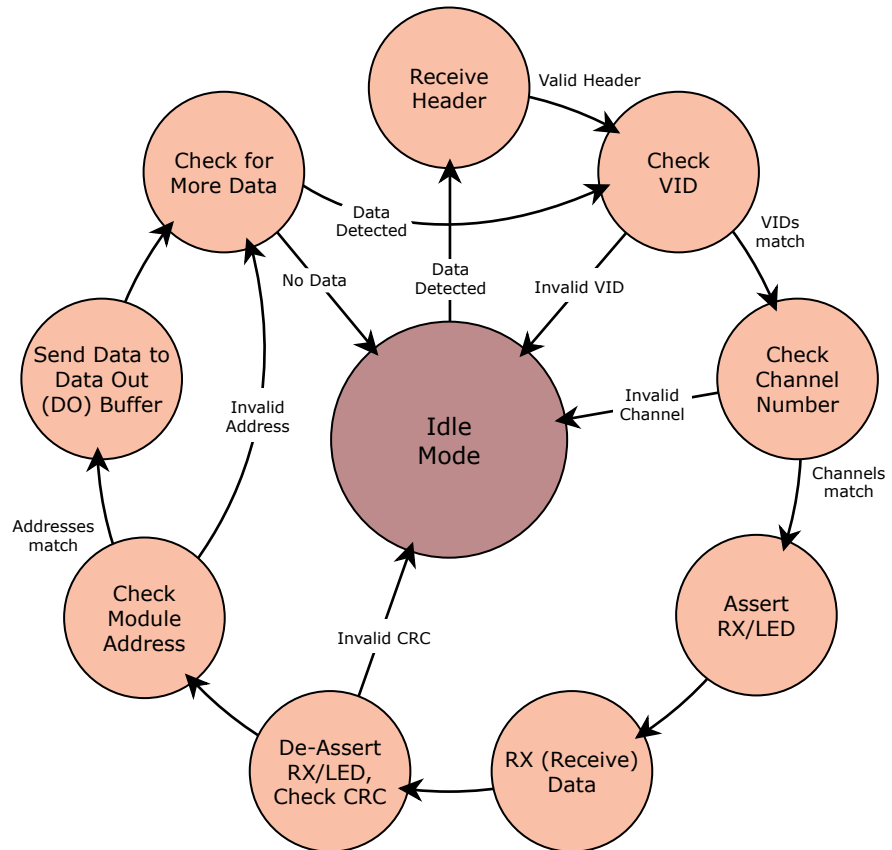

The module returns to Idle Mode after valid data is no longer detected or once an error is detected in the received data. If serial data-to-transmit is stored in the DI buffer while the module is giving precedence to Receive Mode, the data will be transmitted after the module finishes receiving data and returns to Idle Mode.

Sleep Modes

Sleep Modes enable the XCite Radio Modem to go into states of low power-consumption when not in use. Any of three Sleep Modes configurations can be used:

1. Host Controlled
2. Wake on RF activity
3. Wake on Serial Port activity

To enter Sleep Mode, one of the following must occur (In addition to SM (Sleep Mode) Command having a non-zero value):

- The radio modem must be idle (no data transmission or reception) for a user-defined period of time [See ST (Time before Sleep) Command]
- The Sleep Pin (Pin 2) is de-asserted

Once in Sleep Mode, the radio modem does not transmit or receive data until it first returns to Idle Mode. The return into Idle Mode is triggered by the de-assertion of Pin 2 or the arrival of a serial byte through Pin 4 (Data In). Sleep Mode is enabled and disabled using SM Command.

The following table lists MaxStream’s Sleep Mode configurations and the requirements needed to transition into and out of Sleep Mode:

Table 5. Sleep Mode Configurations

Sleep Mode Setting	Transition into Sleep Mode	Transition out of Sleep Mode	Related Commands	Power Consumption
Pin Sleep (SM=1)	Microcontroller can shut down and Wake-up modules. Assert (high) Sleep Pin (Pin 2). Note: Module will complete a transmission or reception before activating Pin Sleep.	De-Assert (low) Sleep pin (Pin 2)	SM	20 μ A
Serial Port Sleep (SM=2)	Automatic transition into Sleep Mode after user-defined period of inactivity (no transmitting or receiving). Period of inactivity set using ST Command.	When serial byte is received on the DI pin (Pin 4)	SM, ST	1 mA
Cyclic Sleep (SM=3-8)	Transitions into and out of Sleep Mode in cycles (user-selectable wake-up interval of time (½ second to 16 seconds) set by SM Command). The Cyclic Sleep interval time must be shorter than “Wake-up Initializer Timer” (set by LH Command). (Can be forced into Idle Mode using Sleep Pin if PW (Pin Wake-up) Command is issued.)		HT, LH, PW, SM, ST	typically 76 μ A (when sleeping)

Pin Sleep (SM = 1)

<Lowest Power Configuration> In order to achieve this low-power state, Pin 2 must be asserted (high). The module remains in Pin Sleep until the Sleep pin is de-asserted. The module will complete a transmission or reception before activating Pin Sleep.

After enabling Pin Sleep (SM (Sleep Mode) Parameter = 1), Pin 2 controls whether the XCite Module is active or in Sleep Mode. When Pin 2 is asserted (high), the module transitions to Sleep Mode and remains in its lowest power-consuming state until the Sleep pin is de-asserted. The XCite Module requires 40ms to transition from Sleep Mode to Idle Mode. Pin 2 is only active if the module is setup to operate in this mode; otherwise the pin is ignored. Once in Pin Sleep Mode, Pin 1 (\overline{CTS}) is de-asserted (high), indicating that data should not be sent to the module. Pin 8 (PWR) is also de-asserted (low) when the module is in Pin Sleep Mode.

Serial Port Sleep (SM = 2)

Serial Port Sleep is a Sleep Mode setting in which the module runs in a low power state until data is detected on the DI pin.

When Serial Port Sleep is enabled, the module goes into Sleep Mode after a user-defined period of inactivity (no transmitting or receiving of data). This period of time is determined by ST (Time before Sleep) Command. The module returns to Idle Mode once a character is received through the DI pin.

Cyclic Sleep (SM = 3-8)

Cyclic Sleep is the Sleep Mode setting in which the XCite Module enters into a low power state and awakens periodically to determine if any transmissions are being sent.

When Cyclic Sleep settings are enabled, the XCite Module goes into Sleep Mode after a user-defined period of inactivity (no transmission or reception on the RF channel). The user-defined period is determined by ST Parameter. [See ST (Time before Sleep) Parameter]

While the module is in a low-power state, Pin 1 ($\overline{\text{CTS}}$) is de-asserted (high) to indicate that data should not be sent to the module during this time. When the module awakens to listen for data, Pin 1 ($\overline{\text{CTS}}$) is asserted and any data received on the DI Pin is transmitted. Pin 8 (PWR) is also de-asserted (low) when the module is in Cyclic Sleep Mode. Pins 1 and 8 are asserted each time the module cycles into Idle Mode to listen for valid data packets and de-asserts when the module returns to Sleep Mode.

The module remains in Sleep Mode for a user-defined period of time ranging from 0.5 seconds to 16 seconds (SM Parameters 3 through 8). After this interval of time, the module returns to Idle Mode and listens for a valid data packet for 100 ms. If the module does not detect valid data (on any frequency), the module returns to Sleep Mode. If valid data is detected, the module transitions into Receive Mode and receives the incoming packets. The module then returns to Sleep Mode after a Period of inactivity that is determined by ST "Time before Sleep" Parameter.

The module can also be configured to Wake-up from cyclic sleep when the SLEEP Pin (Pin 2) is de-asserted (low). To configure a module to operate in this manner, PW (Pin Wake-up) Command must be issued. Once the Pin 2 (Sleep Pin) is de-asserted, the module is forced into Idle Mode and can begin transmitting or receiving data. It remains active until no data is detected for the period of time specified by the ST parameter, at which point it resumes its low-power cyclic state.

Note: The cyclic interval time defined by SM (Sleep Mode) Command must be shorter than the interval time defined by LH ("Wake-up Initializer Timer") Command. For example: If SM=4 (Cyclic 1.0 second sleep), the LH Parameter should equal 0xB ("1.1" seconds). With these parameters set, there is no risk of the receiving module being asleep for the duration of the wake-up initializer transmission. The following section "Cyclic Scanning" explains in further detail the relationship between "Cyclic Sleep" and "Wake-up Initializer Timer"

Cyclic Scanning

Each RF transmission consists of a wake-up initializer and payload data. The wake-up initializer contains initialization information and all receiving modules must Wake-up during the wake-up initializer portion of data transmission in order to synchronize with the transmitter and receive the data.

Figure 15. Correct Configuration (LH > SM)

The length of the wake-up initializer exceeds the time interval of Cyclic Sleep. The receiver is guaranteed to detect the wake-up initializer and receive the accompanying payload data.

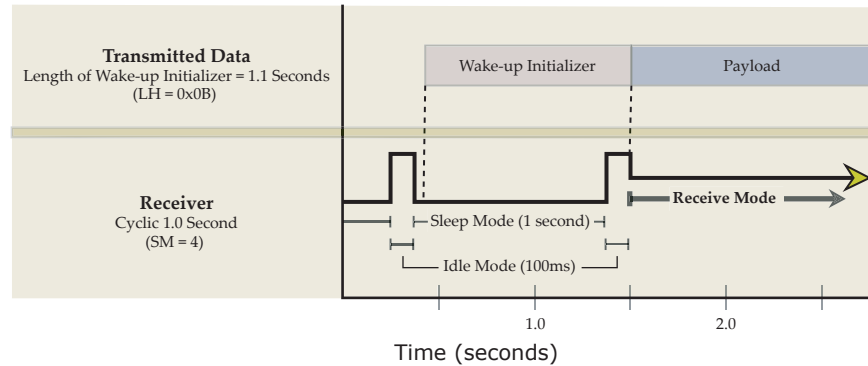
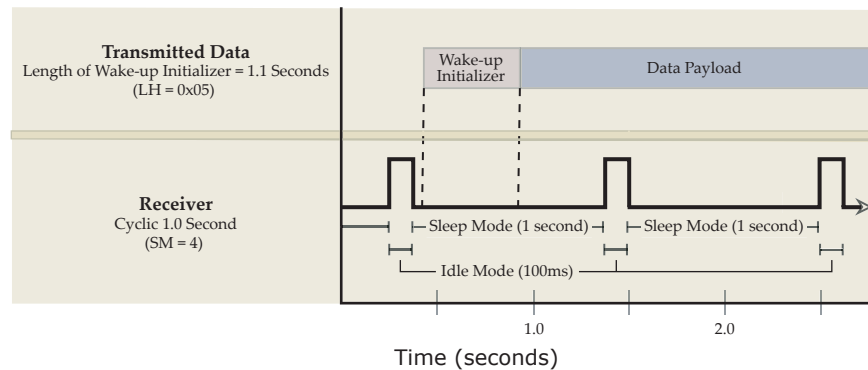

Figure 16. Incorrect Configuration (LH < SM)

The length of the wake-up initializer is shorter than the time interval of Cyclic Sleep. This configuration is vulnerable to the receiver waking and missing the wake-up initializer (and therefore also the accompanying payload data).



The wake-up initializer is sent with the initial transmitted packet after a user-defined period of inactivity (no serial or RF data is sent or received). This period of inactivity is adjusted using HT Command. [See HT (Time before Wake-up Initializer) Parameter] Sending a wake-up initializer (length slightly exceeds the cyclic sleep time interval) assures that the receiver will detect the new transmission and will be able to receive the accompanying data. If the sleeping module misses the wake-up initializer due to interference and does not respond as expected, a new wake-up initializer can be sent using FH (Force Wake-up Initializer) Command.

AT Command Mode

AT Command Mode provides access to AT-Settable parameters. These parameters extend flexibility in configuring modules to fit specific design criteria such as networking modules. Not all of the parameters in the XCite Module can be adjusted using AT Commands.

AT Command Mode Protocol

Enter AT Command Mode

To issue XCite AT Commands, you must first transition out of Idle Mode and into AT Command Mode.

To enter into AT Command Mode, use any of the following means:

1. Through **X-CTU Software**: When using the X-CTU Software, any of the buttons that read or write modem parameters automatically trigger entrance into AT Command Mode. To successfully enter into AT Command Mode in this manner, the serial data baud rate [BD (Baud Rate) Parameter] of the modem must be equal to that of the PC Serial Com Port [Settable using the "PC Settings" tab of the X-CTU Software.] The X-CTU Software can be downloaded from: www.maxstream.net/helpdesk/.
2. Through **Serial Communications Software** ("X-CTU", "HyperTerminal", "Pro Comm", etc.): When using serial communications software to enter into AT Command Mode, users must send the "AT Command Mode Sequence". The default sequence is as follows:
 - a. No characters sent for 1 second. [Time can be modified using BT (Guard Time Before) Parameter]
 - b. Input three (3) plus characters ("+++") within one (1) second. [Character can be modified using CC (Command Sequence Character) Parameter.]
 - c. No characters sent for one (1) second. [Time can be modified using the AT (Guard Time After) Parameter.]

"AT" & "BT" times must always be observed.
3. **Assert (low) the CONFIG pin***, then power the modem off and then on again. (If using the MaxStream Interface Board, power and configuration switches are available to facilitate this process.)

Important: * Never tie the **CONFIG** pin to the microprocessor.

Configure and Read Module Parameters

Once in AT Command Mode, parameters can be configured and read using AT Commands. Parameters changed while in AT Command Mode must be saved to non-volatile memory using WR (Write) Command for the changes to persist in memory. If WR Command is not issued, the parameters will be reset to their previously stored value the next time the module is powered-up.

The "Modem Configuration" chapter is dedicated to explaining the methods needed to configure and read module parameters. The following sections explain the protocols and syntax required to configure and read module parameters.

Syntax

When using serial communications software, ASCII commands and parameters are not case sensitive. The optional space can be any non-alpha-numeric character and XCite Modules require parameter values be hexadecimal.

Figure 17. Syntax for sending AT Commands

(Sequence must be sent within 20 seconds of entering into AT Command Mode)

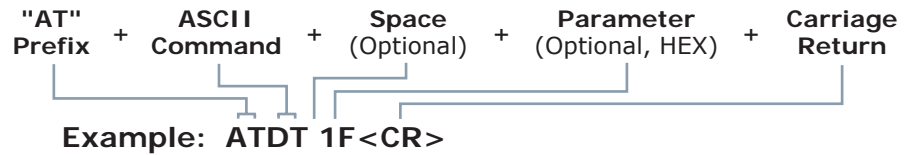

In example above, the "ATDT 1F" sequence would change the modem's networking address to a hexadecimal value of "1F" (decimal 31).

Queries

To query the current value of a particular parameter, send the corresponding AT command without any parameters (followed by a carriage return).

Multiple Commands

Multiple AT commands can be entered on one line with one carriage return at the end of the line. Each command must be delimited by a comma (and an optional space). The "AT" prefix is only sent before the first command and should not be included with subsequent commands in a line.

System Response

After executing a recognized AT command, the module responds with "OK<CR>". If an unrecognized command or a command with a bad parameter is received, the module responds with "ERROR<CR>". Modified AT values are reset to previous stored values upon module power-down unless the WR (Write) Command was issued to save parameters to non-volatile memory.

Basic methods for sending AT Commands.

Example:	Both of the following examples change the user-defined Destination Address to 0x1A0D and save changes to non-volatile memory.
Method 1 (One line per command)	
<u>Issue AT Command</u>	<u>System Response</u>
+++	OK<CR> (Enter into AT Command Mode)
ATDT 1A0D<CR>	OK<CR> (Change Destination Address)
ATWR<CR>	OK<CR> (Write to non-volatile memory)
ATCN<CR>	OK<CR> (Exit AT Command Mode)
Method 2 (Multiple commands on one line)	
<u>Issue AT Command</u>	<u>System Response</u>
+++	OK<CR>
ATDT 1A0D, WR, CN<CR>	OK<CR>
	OK<CR> (Write to non-volatile memory)
	OK<CR> (Exit AT Command Mode)

<CR> = Carriage Return

Exit AT Command Mode

To exit AT Command Mode

1. If no valid AT Commands are received within the time specified by CT (Time Out) Parameter, the module automatically returns to Idle Mode.
2. AT Command Mode can be exited explicitly by issuing CN (Exit AT Command Mode) Command.

Configuration Software

X-CTU Software

X-CTU is MaxStream-provided software used to configure XCite Radio Modems. It is the only means that can be used to set all three command parameter types [AT Commands and Non-AT Settable Parameters].

X-CTU Software is organized into the following four tabs:

- **PC Settings** tab - Setup PC serial ports to interface with an XCite module assembly or PKG RF Modem
- **Range Test** tab – Test XCite Radio Modem range
- **Terminal** tab – Configure and read XCite Radio Modem parameters using AT Commands
- **Modem Configuration** tab – Configure and read XCite Radio Modem parameters

Figure 18. X-CTU User Interface (PC Settings, Range Test, Terminal & Modem Configuration tabs)

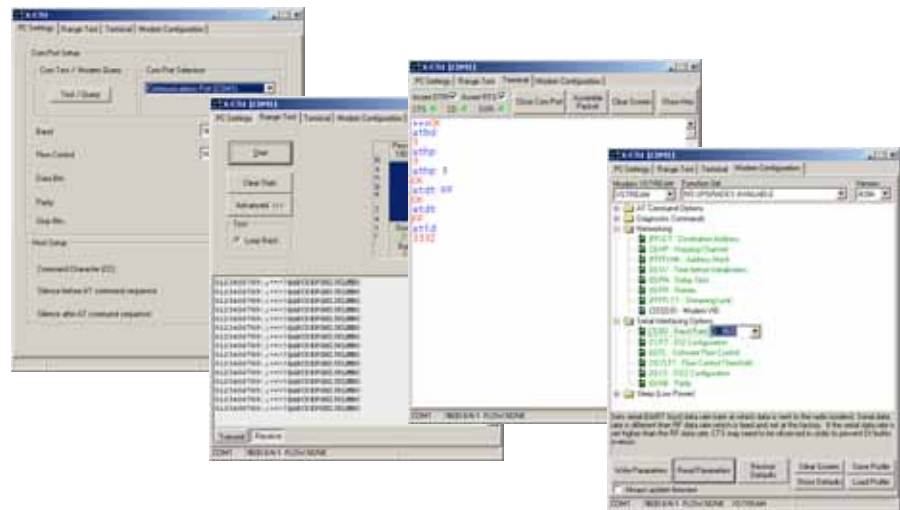

Install X-CTU software

Double-click the "setup_X-CTU.exe" file and follow prompts of the installation screens. This file is located in the 'software' folder of the MaxStream CD and also under the 'Downloads' section of the following web page: www.maxstream.net/helpdesk/

Using X-CTU software

In order to use the X-CTU software, a module assembly (an XCite OEM RF Module mounted to a MaxStream Interface Board) or XCite PKG RF Modem be connected to the serial port of a PC. The baud rate of the serial port ("PC Settings" tab) must match the baud rate of the radio modem (BD (Baud Rate) Command on the "Modem Configuration" tab).

Serial Communications Software (for AT Commands Only)

Serial Communications Software can be used to issue AT Commands, but cannot be used to set Non-AT Settable Parameters. A terminal program has been built into the X-CTU software. Other terminal programs such as "HyperTerminal" can also be used to read and configure parameters. Use the syntax illustrated in Figure 17 when issuing AT Commands using terminal software.

Radio Modem Configuration

XCite Radio Modems can operate in both Single Frequency and Hopping Channel modes (selectable using the "Function Set" dropdown list of the "Modem Configuration" tab of the MaxStream-provided X-CTU Software). Each XCite Radio Modem is shipped with a unique parameter set in its memory. Parameters within the set are organized under the following command and parameter types:

- AT Commands
- Non-AT Settable Parameters

Command & Parameter Types

AT Commands

AT Commands are a set of commands that allow users to customize and configure the XCite Module to meet specific needs. [AT Commands are listed in the table on the next page.]

AT Commands can be used to change module parameters at any time by entering into AT Command Mode and sending AT Commands to the module. When WR (Write) Command is issued, parameters are saved to non-volatile memory. "Saving to non-volatile memory" means that when the module is powered off, adjusted parameter values persist in the module's memory and will be loaded during the next power-up. Otherwise, modified parameter values revert to previously saved values the next time the module is powered-up.

Users can transition the XCite Module into AT Command Mode and modify AT Commands Parameters using any of the following means:

- X-CTU Software (MaxStream-provided)
- Serial Communications Software ("X-CTU", "HyperTerminal", "Pro Comm", etc.)
- Microcontroller

In order to utilize the AT Commands, users must enter into "AT Command Mode". AT Commands can then be sent to the module using ASCII commands and parameters.

Non-AT Settable Parameters

Non-AT Settable Parameters can **only** be adjusted using the MaxStream-provided X-CTU Software. To modify Non-AT Settable Parameter, connect the module to the serial com port of a PC (interface board is necessary for RS-232 connection) and modify parameter values through the X-CTU Software interface. These parameters enable features that need to be set before the module is used in the field. [Non-AT Settable Parameters are listed in table 7.]

Non-AT Settable Parameters can be modified using the following means:

- X-CTU Software (MaxStream-provided)

XCite Command & Parameter Reference

XCite Commands and Parameters are listed under the following command categories:

- AT Command Mode Options
- Diagnostic
- Networking
- Serial Interfacing
- Sleep Mode (Low Power)

Table 6. AT Commands

(Settable/Readable using X-CTU Software, Serial Communications Software or Microcontroller)

AT Designator	Command Description	Parameters	Command Category	# Bytes Returned	Factory Default
CD	DI3 Configuration. Redefines the RX LED I/O line (RX LED signal).	Range: 0 – 2 0 = RX LED 1 = high 2 = low	Serial Interfacing	1	0
CN	Exit AT Command Mode. Explicitly exit radio modem from AT Command Mode and return it to Idle Mode.	-	AT Command Mode Options	-	-
CS	DO2 Configuration. Select behavior of DI2 (Digital Output 2) between CTS and RS-485 options.	Range: 0 – 4 0 = normal CTS 1 = RS-485 enable low 2 = high 3 = RS-485 enable high 4 = low	Serial Interfacing	1	0
DB	Receive Signal Strength. Returns the signal strength (in decibels) of the last received packet.	Range: 0x25 – 0x6A (Read-only)	Diagnostic	1	-
DT	Destination Address. Set the address that identifies the destination of the RF packet. Only radio modems having matching addresses can communicate with each other.	Range: 0 – 0xFFFF	Networking	2	0
FH	Force Wake-up Initializer. Force a Wake-up Initializer to be sent on the next transmission. WR (Write) Command does not need to be issued with FH Command. Use only with cyclic sleep modes (SM = 3-8) active on remote modules.	-	Sleep (Low Power)	-	-
HP	Channel *. Select "Hopping" or "Single Frequency" channel on which the radio modem is to communicate. Channels are not non-interfering.	Range (Hopping): 0 – 6 Range (Single Frequency): 0 – 0x18	Networking	1	0
HV	Hardware Version. Read the hardware version of the modem.	Range: 0 – 0xFFFF (Read-only)	Diagnostic	2	-
MK	Address Mask. Set address mask to configure local and global address space.	Range: 0 – 0xFFFF	Networking	2	0xFFFF (65535d)
RE	Restore Defaults. Restore AT-settable parameters to the factory default configuration.	-	(Special)	-	-
SH	Serial Number High. Read High 16 bits of unique serial number of radio modem.	0 – 0xFFFF (Read-only)	Diagnostic	2	-
SL	Serial Number Low. Read Low 16 bits of unique serial number of radio modem.	0 – 0xFFFF (Read-only)	Diagnostic	2	-
VR	Firmware Version. Read firmware version currently loaded on radio modem.	0 x 0xFFFF (Read-only)	Diagnostic	2	-
WR	Write. Write parameters to radio modem's non-volatile memory in order for changes to persist through next power-up or reset.	-	(Special)	-	-

* To select the Channel Mode: Select mode from the 'Function Set' dropdown list on the "Modem Configuration" tab of the X-CTU Software. Then click the 'Write Parameters' button.

Table 7. Non-AT Settable Parameters (Settable/Readable using X-CTU Software only)

AT Designator	Command Description	Parameters	Command Category	# Bytes Returned	Factory Default
AT	Guard Time After. Set required DI pin silent time after the Command Sequence Characters of the AT Command Mode Sequence (BT+ CC + AT).	Range: 0 – 0xFFFF (x 1 ms)	AT Command Mode Options	2	0x1F4 (500d)
BD	Baud Rate. Set serial data rate (baud rate at which radio modem interfaces with host). Serial data rate is different than RF data rate which is fixed and factory-set. If the serial data rate is set higher than RF data rate, CTS may need to be observed to prevent DI buffer overrun.	Range: 0 – 6 (1200 - 57600 bps)	Serial Interfacing	1	Set to equal radio modem's fixed RF data rate.
BI	Number of Bits. (7 or 8) – Sets number of data bits per character (bits between start and stop bits).	Range: 0 – 1 0 = 7 bits 1 = 8 bits	Serial Interfacing	1	1
BT	Guard Time Before. Set required DI pin silent time before the Command Sequence Characters of the Command Mode Sequence (BT+ CC + AT).	Range: 0 – 0xFFFF (x 1 ms)	AT Command Mode Options	2	0x1F4 (500d)
CC	Command Sequence Character. Set the ASCII character to be used between Guard Times of the AT Command Mode Sequence (BT+ CC + AT). The AT Command Mode Sequence enters the radio modem to AT Command Mode (from Idle Mode).	Range: 0x20 – 0x7F	AT Command Mode Options	1	0x2B (plus sign (+) in ASCII)
CT	Time before Exit AT Command Mode. Set time period of inactivity (no valid commands received) after which radio modem automatically exits from AT Command Mode.	Range: 0x02 – 0xFFFF (x 100 ms)	AT Command Mode Options	2	0xC8 (200d)
FL	Software Flow Control. Enable serial software flow control on the radio modem. (Hardware flow control (CTS) is on by default.)	Range: 0 - 1 0 = disable 1 = enabled	Serial Interfacing	1	0
HT	Time before Wake-up Initializer. Set time period of inactivity (no serial or RF data is sent or received) before a Wake-up Initializer is sent. Base station tracks awake-status of remote radios. HT of base radio should be set shorter than ST of remote radios.	Range: 0 – 0xFFFF (x 100 ms)	Sleep (Low Power)	2	0xFFFF (no wake-up Initializer will be sent)
ID	Modem VID. Read radio modem VID (Vendor Identification Number). Only radio modems with matching VIDs can communicate with each other.	Range: 0 – 0x7FFF (above this range is Read-only)	Networking	2	0x3332
LH	Wake-up Initializer Time. Set time of the Wake-up Initializer used to wake remote radios that are in cyclic sleep mode. Time of Wake-up Initializer should be longer than that of the remote radio's cyclic sleep cycle (SM 3 - 8).	Range: 0 – 0xFF (x 100 ms)	Sleep (Low Power)	1	1
NB	Parity. Select parity format. Settings 0-4 transfer only 8 bits out the antenna port and generate the parity bit on the radio modem receiving side.	Range: 0 – 4 0 = 8-none-1, 7-any-1 1 = 8-even-1 2 = 8-odd-1 3 = 8-mark-1, 8-none-2 4 = 8-space-1	Serial Interfacing	1	0
PW	Pin Wake-up. Enable pin wake-up from Cyclic Sleep Mode.	Range: 0 – 1 0 = disabled 1 = enabled	Sleep (Low Power)	1	0
RT	DI2 Configuration. Enable $\overline{\text{RTS}}$ Mode ($\overline{\text{RTS}}$ /CMD signal - pin 5 of OEM RF Module).	Range: 0 - 1 0 = Disabled 1 = $\overline{\text{RTS}}$ flow control	Serial Interfacing	1	0
SB	Stop Bits. Set number of stop bits.	Range: 0 – 1 0 = 1 stop bit 1 = 2 stop bits	Serial Interfacing	1	0
SM	Sleep Mode. Specify Sleep Mode settings.	Range: 0 – 8 0 = No sleep 1 = Pin Sleep 2 = Serial Port Sleep 3 to 8 = Cyclic intervals ranging from 0.5 to 16.0 seconds	Sleep (Low Power)	1	0
ST	Time before Sleep. Set time period of inactivity (no serial or RF data is sent or received) before activating Sleep Mode. Use with Cyclic Sleep and Serial Port Sleep. (see SM Command)	Range: 0x10 – 0xFFFF (x 100 ms)	Sleep (Low Power)	2	0x64 (100d)

Individual Command & Parameter Descriptions

Commands and parameters are listed alphabetically. Parameter types and categories are designated between "< >" symbols. For example: <AT Command: Networking>. "AT Command" is the command/parameter type and "Networking" is the command/parameter category.

AT (Guard Time After) Parameter

<Non-AT Settable Parameter: AT Command Options> AT Parameter is used to set the DI pin silent time that follows the command sequence character (CC Parameter). By default, 1 half of a second (500 milliseconds) must elapse before entering another character. The AT Command Mode Sequence used to enter AT Command Mode is as follows:

- No characters sent for 1 millisecond [BT (Guard Time Before) Parameter]
- Send three plus characters "+++" [CC (Command Sequence Character) Parameter]
- No characters sent for 1 millisecond [AT (Guard Time After) Parameter]

All of the values in this sequence can be adjusted. AT Parameter is used to adjust the period of silence that follows the command sequence character.

Parameter Range: 0x02 – 0xFFFF (x 1 millisecond)

of bytes returned: 2

Default Parameter Value: 0x1F4 (500 decimal)

Related Commands: BT (Silence before Sequence), CC (Commands Sequence Character)

BD (Baud Rate) Parameter

<Non-AT Settable Parameter: Serial Interfacing> BD Parameter allows the user to adjust the UART baud rate and thus modify the rate at which serial data is sent to the module. Baud rates range from 1200 to 57600 baud (bps). The new baud rate does not take effect until CN (Exit AT Command Mode) Command is issued.

Note: If the serial data baud rate is set to exceed the fixed RF data baud rate of the XCite radio modem, \overline{CTS} flow control may need to be implemented as is described in the "I/O Pin Signals" section of this Manual.

Parameter Range: 0 – 6

of bytes returned: 1

Default Parameter Value: Set to equal radio modem's fixed RF data rate (baud).

Parameter Value	Configuration
0	1200 Baud (bps)
1	2400
2	4800
3	9600
4	19200
5	38400
6	57600

BI (Number of Bits) Parameter

<Non-AT Settable Parameter: Serial Interfacing> BI Parameter allows the user to define the number of data bits between the start and stop bits. Setting 7 bits and Mark or Space parity (NB Parameter) will result in a setting of 7 bits and no parity.

Parameter Range: 0 – 1

of bytes returned: 1

Default Parameter Value: 1

Parameter Value	Configuration
0	7 bits
1	8

BT (Guard Time Before) Parameter

<Non-AT Settable Parameter: AT Command Options> BT Parameter is used to set the DI pin silent time that precedes the command sequence character (CC Parameter). By default, 1 half of a second (500 milliseconds) must elapse before entering another character. The AT Command Mode Sequence used to enter AT Command Mode is as follows:

- No characters sent for 1 millisecond [BT (Guard Time Before) Parameter]
- Send three plus characters “+++” [CC (Command Sequence Character) Parameter]
- No characters sent for 1 millisecond [AT (Guard Time After) Parameter]

All of the values in this sequence can be adjusted. AT Command is used to adjust the period of silence that precedes the command sequence character.

Parameter Range: 0 - 0xFFFF (x 1 millisecond)

of bytes returned: 2

Default Parameter Value: 0x1F4 (500 decimal)

Related Commands: AT (Guard Time After), CC (Commands Sequence Character)

CC (Command Sequence Character) Parameter

<Non-AT Settable Parameter: AT Command Options> CC Parameter is used to adjust the command sequence character used when entering AT Command Mode.

The AT Command Mode Sequence used to enter AT Command Mode is as follows:

- No characters sent for 1 millisecond [BT (Guard Time Before) Parameter]
- Send three plus characters “+++” [CC (Command Sequence Character) Parameter]
- No characters sent for 1 millisecond [AT (Guard Time After) Parameter]

Parameter Range: 0x20 – 0x7F

of bytes returned: 1

Default Parameter Value: 0x2B (ASCII “+” sign)

Related Parameters: AT (Guard Time After), BT (Guard Time Before)

CD (DO3 Configuration) Command

<AT Command: Serial Interfacing> Used to redefine the RX LED I/O line.

AT Command: CD

Parameter Range: 0 – 5

of bytes returned: 1

Default Parameter Value: 0

Parameter Value	Configuration
0	RX LED
1	High
2	Low

CN (Exit AT Command Mode) Command

<AT Command: AT Command Mode Options> CN Command allows users to explicitly exit AT Command Mode and return the radio modem into Idle Mode.

AT Command: CN

CS (DO2 Configuration) Command

<AT Command: Serial Interfacing> CS Command is used to modify the behavior of the $\overline{\text{CTS}}$ signal such that it either provides RS-232 flow control, enables RS-485 transmission / reception or determines RS-422 transmit enable. By default, $\overline{\text{CTS}}$ provides RS-232 flow control. CS Parameter must be adjusted for the module to operate in RS-485/422 environments.

AT Command: CS

Parameter Range: 0 – 4

of bytes returned: 1

Default Parameter Value: 0

Parameter Value	Configuration
0	Normal
1	RS-485 Enable (low)
2	high
3	RS-485 Enable (high)
4	low

CT (Time before Exit AT Command Mode) Parameter

<Non-AT Settable Parameter: AT Command Options> AT Command Mode can be exited manually using CN (Exit AT Command Mode) Command or, after a given time of inactivity, the module exits AT Command Mode on its own and return to Idle Mode. CT Command sets the amount of time before AT Command Mode is exited automatically. If no characters are received before this time elapses, the module will return to Idle Mode.

Parameter Range: 0x02 – 0xFFFF [x 100 ms]

of bytes returned: 2

Default Parameter Value: 0xC8 (20 seconds decimal)

DB (Receive Signal Strength) Command

<AT Command: Diagnostic> DB Parameter returns the receive signal strength (in decibels) of the last received packet. This Parameter is useful in determining range characteristics of the XCite Modules under various conditions.

AT Command: DB

Parameter Range: 0x25 – 0x6A [Read-only]

of bytes returned: 1

DT (Destination Address) Command

<AT Command: Networking> DT Command is used to set the address of the XCite Radio Modem. XCite Radio Modems use three network layers – the Vendor Identification Number (ATID), Channels (ATHP) and Destination Addresses (ATDT).

DT Command assigns an address to a radio modem that enables it to communicate only with radio modems that have matching addresses. This is similar to interconnecting several PCs under a common hub. All radio modems that share the same destination address can communicate freely with each other. Radio Modems in the same network with a different destination address (than that of the transmitter) will listen to all transmissions to stay synchronized, but will not send any of the data out their serial ports.

AT Command: DT

Parameter Range: 0 - 0xFFFF

of bytes returned: 2

Default Parameter Value: 0

Related Commands: ID (Modem ID), HP (Channel), MK (Address Mask)

FH (Force Wake-up Initializer) Command

<AT Command: Sleep (Low Power)> FH Command is used to force a Wake-up Initializer to be sent on the next transmission. WR (Write) Command does not need to be issued with FH Command. Use only with cyclic sleep modes active on remote modules.

FL (Software Flow Control) Parameter

<Non-AT Settable Parameter: Serial Interfacing> FL Parameter is used to adjust serial flow control. Hardware flow control is implemented with the XCite Radio Modem as the $\overline{\text{CTS}}$ pin (which regulates when serial data can be transferred to the radio modem). FL Parameter can be used to allow software flow control to also be enabled. The XON character to use is 0x11 ("17" decimal). The XOFF character to use is 0x13 ("19" decimal)

Parameter Range: 0 – 1

of bytes returned: 1

Default Parameter Value: 0

Parameter Value	Configuration
0	No Software Flow Control
1	Use Software Flow Control

HP (Channel) Command

<AT Command: Networking> HP Command is used to set the radio modem channel number. A channel is one of three layers of addressing available to the XCite Radio Modem. In order for radio modems to communicate with each other, the modules must have the same channel number since each channel uses a different hopping sequence or single frequency. Different channels can be used to prevent modules in one network from listening to transmissions of another.

The XCite Radio Modem can operate both in Hopping and Single Frequency Channel Modes. Switching between Single Channel and Hopping Modes can only be done only using the "Function Set" dropdown list on the "Modem Configuration" tab of the X-CTU Software.

AT Command: HP

Hopping Channel Range: 0 – 6

Single Frequency Channel Range: 0 - 0x18

of bytes returned: 1

Default Parameter Value: 0

Related Parameters: DT (Destination Address), ID (Modem ID), MK (Address Mask)

A "Hopping Channel" is a channel comprised of a group of frequencies. When in Hopping Channel Mode, the radio modem hops between the frequencies them when transmitting data. This option utilizes FHSS (Frequency Hopping Spread Spectrum) technology. This option helps bolster security in wireless data communications and also makes the system less prone to interference.

The 25 center frequencies available in **Single Frequency Channel Mode** are spaced 300 KHz apart. Since each channel occupies a 500 KHz bandwidth, adjacent channels therefore overlap. If modules are used in the same vicinity but on different channels, the channels used should occupy every other channel at a minimum separation. If channels used on different radio modems can be separated more they should be. This will provide for more isolation and less interference.

Single Frequency Channel Mode Parameters

Parameter Value	Frequency (MHz)
0x00	910.5
0x01	910.8
0x02	911.1
0x03	911.4
0x04	911.7
0x05	912.0
0x06	912.3
0x07	912.6
0x08	912.9
0x09	913.2
0x0A	913.5
0x0B	913.8
0x0C	914.1
0x0D	914.4
0x0E	914.7
0x0F	915.0
0x10	915.3
0x11	915.6
0x12	915.9
0x13	916.2
0x14	916.5
0x15	916.8
0x16	917.1
0x17	917.4
0x18	917.7

HT (Time before Wake-up Initializer) Parameter

<Non-AT Settable Parameter: Sleep (Low Power)> If any modules within range are running in a “Cyclic Sleep Setting”, a wake-up initializer must be sent by the transmitter for the other radio modems to synchronize to the transmitter [see LH (“Wake-up Initializer Timer”) Command]. When a receiving radio modem in Cyclic Sleep wakes, it must detect the wake-up initializer portion of the RF packet in order to synchronize to the transmitter and receive data. HT Parameter sets time period of inactivity (no serial or RF data is sent or received) before a Wake-up Initializer is sent. Base station tracks awake-status of remote radios. HT of base radio should be set shorter than ST (Time before Sleep) of remote radios.

From the receiver perspective, after “HT” time elapses and the ST (Time before Sleep) Parameter is met, the receiver goes into cyclic sleep. Once in cyclic sleep, the radio modem must first detect the wake-up initializer and synchronize to the transmitter before it can receive data. Thus, when time “HT” time elapses, the transmitter then knows it needs to send a long wake-up initializer for all receivers to be able to synchronize to its next transmission. Matching “HT” to the “ST” time on the receiver(s) guarantees that all receivers will detect the next transmission.

Parameter Range: 0 - 0xFFFF [x 100 ms]

of bytes returned: 2

Default Parameter Value: 0xFFFF (long wake-up initializer will not be sent)

Related Parameters: LH (Wake-up Initializer Timer), SM (Sleep Mode), ST (Time before Sleep)

HV (Hardware Version) Command

<AT Command: AT Command Options> Reads and returns the hardware version of the XCite Module.

AT Command: HV

Parameter Range: 0 – 0xFFFF [Read-only]

of bytes returned: 2

ID (Modem VID) Parameter

<Non-AT Settable Parameter: Networking> ID Parameter reads and edits the module’s VID. VID is a MaxStream-specific acronym that stands for “Vendor Identification Number”. Modules can only communicate with other modules having the same VID.

Parameter Range: 0 - 0x7FFF (above this range is Read-only)

of bytes returned: 2

Default Parameter Value: 0x3332

LH (Wake-up Initializer Timer) Parameter

<Non-AT Settable Parameter: Sleep (Low Power)> LH Parameter adjusts the duration of time in which the wake-up initializer is sent. When receiving modules are put into the Cyclic Sleep Mode, they power-down after a period of inactivity (specified by ST (Time before Sleep) Parameter) and will periodically awaken and listen for transmitted data. In order for the receiving modules to initialize with the transmitter, they must detect ~35ms of the wake-up initializer. LH Parameter must be used whenever a receiver is operating in Cyclic Sleep Mode. This lengthens the wake-up initializer to a specific amount of time (in x 100 ms). The long wake-up initializer must be longer than the cyclic sleep time that is determined by SM (Sleep Mode) Command. If the wake-up initializer time were less than the Cyclic Sleep interval, the connection would be at risk of missing the wake-up initializer transmission. The data and figures on the next page illustrate this behavior:

LH Command (continued)

Parameter Range: 0 – 0xFF [x 100 ms]

of bytes returned: 1

Default Parameter Value: 0x01 (0.1 second)

Related Parameters: HT (Time before Wake-up Initializer), SM (Sleep Mode), ST (Time before Sleep)

Figure 19. Correct Configuration (LH > SM)

The length of the wake-up initializer exceeds the time interval of Cyclic Sleep. The receiver is guaranteed to detect the wake-up initializer and receive the accompanying payload data.

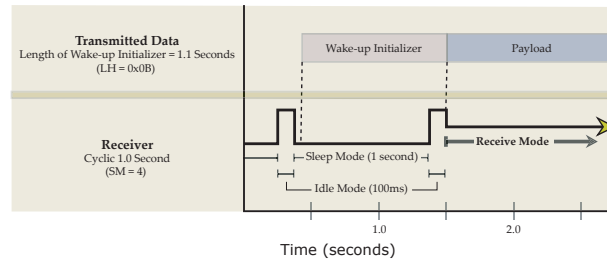
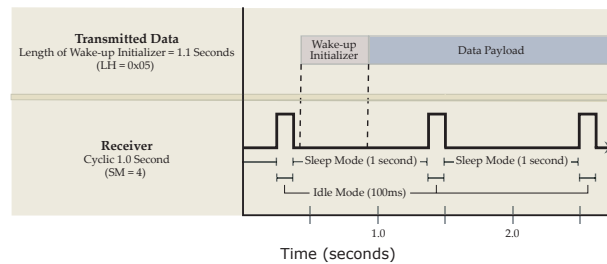

Figure 20. Incorrect Configuration (LH < SM)

The length of the wake-up initializer is shorter than the time interval of Cyclic Sleep. This configuration is vulnerable to the receiver waking and missing the wake-up initializer (and therefore also the accompanying payload data).



MK (Address Mask) Command

<AT Command: Networking> MK Command is used to set the radio modem address mask. All RF packets contain the Destination Address of the transmitting radio modem. When an RF packet is received, the transmitter's Destination Address is logically "ANDed" (bitwise) with the Address Mask of the receiver. The resulting value must match the Destination Address or the Address Mask of the receiver for the packet to be received and sent out the receiving modem serial port. If the "ANDed" value does not match either the Destination Address or the Address Mask of the receiver, the packet is discarded. (All "0" values are treated as "irrelevant" values and ignored.)

AT Command: MK

Parameter Range: 0 – 0xFFFF

of bytes returned: 2

Default Parameter Value: 0xFFFF (When set to this value, the Destination Address of the transmitter must exactly match the Destination Address of the receiver.)

Related Commands: DT (Destination Address), HP (Channel)

NB (Parity) Parameter

<Non-AT Settable Parameter: Serial Interfacing> NB Parameter allows parity for the module to be changed. Parity is an error detection method in which a bit (0 or 1) is added to each group of bits so that it will have either an odd number of 1's or an even number of 1's. For example, if parity is odd, then any group of bits that arrives with an even number of 1's must contain an error.

Parameter Range: 0 - 4

of bytes returned: 1

Default Parameter Value: 0

Parameter Value	Configuration
0	8-bit (no parity) or 7-bit (with any parity)
1	8-bit even parity
2	8-bit odd parity
3	8-bit mark parity
4	8-bit space parity

PW (Pin Wake-up) Parameter

<Non-AT Settable Parameter: Sleep (Low Power)> Under normal operation, a radio modem in Cyclic Sleep Mode cycles from an active state to a low-power state at regular intervals until data is ready to be received. If PW Parameter is set to 1, the SLEEP Pin (Pin 2 of the OEM RF Module) can be used to awaken the module from Cyclic Sleep. If the SLEEP Pin is de-asserted (low), the radio modem will be fully operational and will not go into Cyclic Sleep. Once SLEEP is asserted, the radio modem will remain active for the period of time specified by ST (Time before Sleep) Command, and will return to Cyclic Sleep Mode (if no data is ready to be transmitted). PW Command is only valid if Cyclic Sleep has been enabled using SM Command.

Parameter Range: 0 - 1

of bytes returned: 1

Default Parameter Value: 0

Related Parameters: SM (Sleep Mode), ST (Time before Sleep)

Parameter Value	Configuration
0	Disable Pin Wake-Up
1	Enable Pin Wake-Up

RE (Default Configuration) Command

<AT Command: AT Command Options> RE Command restores all AT-settable parameters to factory default settings. However, RE Command will not write the default values to non-volatile memory. Unless the WR (Write) Command is issued after the RE Parameter, the default settings will not be saved in the event of radio modem reset or power-down.

AT Command: RE

Related Command: WR (Write)

RT (DI2 Configuration) Parameter

<Non-AT Settable Parameter: Serial Interfacing> RT Parameter enables $\overline{\text{RTS}}$ Mode.

Parameter Range: 0 - 1

of bytes returned: 1

Default Parameter Value: 0

Parameter Value	Configuration
0	Disabled
1	Enables RTS Handshaking

SB (Stop Bits) Parameter

<Non-AT Settable Parameter: Serial Interfacing> SB Parameter allows the user set the number of stop bits used in data transmission.

Parameter Range: 0 - 1

of bytes returned: 1

Default Parameter Value: 0

Parameter Value	Configuration
0	1 stop bit
1	2 stop bits

SH (Serial Number High) Command

<AT Command: AT Command Options> SH Command reads and returns the module serial number high word.

AT Command: SH

Parameter Range: 0 – 0xFFFF [Read-only]

of bytes returned: 2

Related Command: SL (Serial Number Low)

SL (Serial Number Low) Command

<AT Command: AT Command Options> SL Command reads and reports the module serial number low word.

AT Command: SL

Parameter Range: 0 – 0xFFFF [Read-only]

of bytes returned: 2

Related Command: SH (Serial Number High)

SM (Sleep Mode) Parameter

<Non-AT Settable Parameter: Sleep Mode (Low Power)> SM Parameter is used to adjust Sleep Mode settings. By default, Sleep Mode is disabled and the radio modem remains continually active. SM Parameter allows the radio modem to run in a lower-power state and be configured in one of eight settings.

Cyclic Sleep settings wake the radio modem after the amount of time designated by SM Command. If the radio modem detects a wake-up initializer during the time it is awake, it will synchronize with the transmitting radio modem and start receiving data after the wake-up initializer runs its duration. Otherwise, it returns to Sleep Mode and continue to cycle in and out of sleep until the wake-up initializer is detected. If a Cyclic Sleep setting is chosen, the ST, LH and HT parameters must also be set as described in the "Sleep Mode" section of this manual.

Parameter Range: 0 - 8

of bytes returned: 1

Default Parameter Value: 0

Related Parameters: LH (Wake-up Initializer Timer), HT (Time before Wake-up Initializer), PW (Pin Wake-up), ST (Time before Sleep)

Parameter Value	Configuration
0	No Sleep
1	Pin Sleep
2	Serial Port Sleep
3	Cyclic 0.5 seconds
4	Cyclic 1.0 seconds
5	Cyclic 2.0 seconds
6	Cyclic 4.0 seconds
7	Cyclic 8.0 seconds
8	Cyclic 16.0 seconds

ST (Time before Sleep) Parameter

<Non-AT Settable Parameter: Sleep Mode (Low Power)> ST Parameter sets the period of time (in tenths of seconds) in which the radio modem remains inactive before entering into Sleep Mode. For example, if the ST Parameter is set to 0x64 (“100” decimal), the radio modem will enter into Sleep Mode after 10 seconds of inactivity (no transmitting or receiving). This command can only be used if either Cyclic Sleep or Serial Port Sleep Mode settings have been selected using SM (Sleep Mode) Parameter.

Parameter Range: 0x10 – 0xFFFF [x 100 ms]

of bytes returned: 2

Default Parameter Value: 0x64 (“100” decimal)

Related Parameters: SM (Sleep Mode), LH (Wake-up Initializer Timer), HT (Time before Wake-up Initializer)

VR (Firmware Version) Command

<AT Command: AT Command Options> Reads and returns the currently loaded firmware version of the XCite Radio Modem.

AT Command: VR

Parameter Range: 0 – 0xFFFF [Read-only]

of bytes returned: 2

WR (Write) Command

<AT Command: (Special)> WR Command writes all configurable parameters to non-volatile memory. Using WR Command saves parameters to the radio modem’s persistent memory. (This means that the parameters remain in the radio modem’s memory until explicitly overwritten by future uses of WR Command.)

AT Command: WR

Advanced Networking and Security

Network Layers

The XCite Radio Modems utilize three layers of addressing to communicate between radio modems. The network layers are depicted below. Only radio modems with the matching addresses are able to communicate. The main layers of XCite Networking and Addressing are:

- Vendor Identification Number (ATID)
- Channel (ATHP)
- Destination Address (ATDT)

Figure 21. Network Addressing Layers

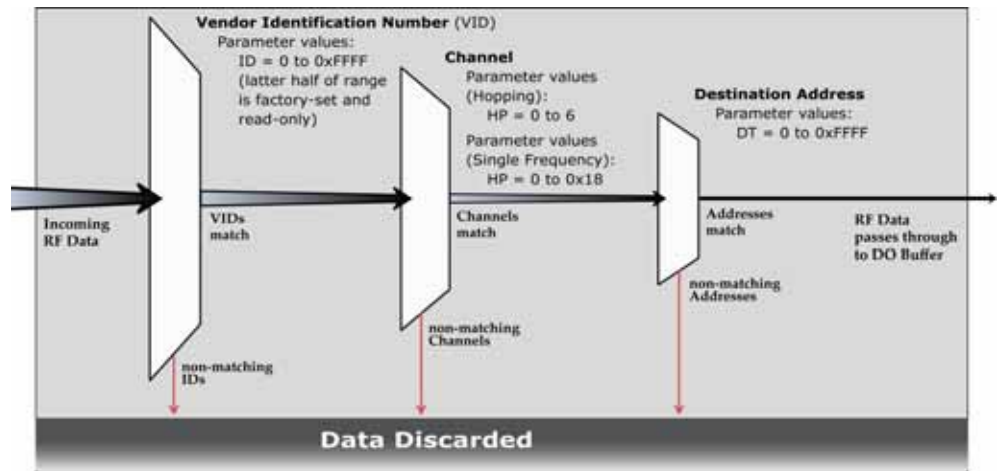

Each network layer provides a separate layer of filtration. The Vendor Identification Number (VID) provides the first layer of filtration through the ID (Modem ID) Parameter. If the incoming RF data carries a matching VID number, the data continues through to the subsequent Channel and Destination Address layers. The Destination Address is the last network layer and provides the most granular form of filtration. If at any point during the incoming RF data flow the numbers in question do not match, the data is discarded.

XCite Modules and RF Modems are built around a peer-to-peer protocol that inherently supports a multidrop type network (similar to RS-485). In their default state, any XCite radio modem will communicate with any other XCite radio modem in its default state.

Vendor Identification Number (ATID)

The bottom half of the ID (Vendor Identification Number) Parameter range is user-settable. The upper half of the range is factory-set and read-only. The value of the ID Command is called the Vendor Identification Number (VID). A unique VID is available upon special request. The VID is programmed to the XCite Module at the factory and is stored in the module's permanent memory. Only modules with matching VIDs can communicate with each other.

VID addressing ensures that radio modems ignore transmissions and receptions of XCite Radio Modems having a different VID in the same vicinity. To request a unique VID, contact MaxStream to obtain the VID Request Form.

Channel (ATHP)

Channels provide a network layer from which channels can be used for isolation. HP (Channel) Parameter is used to define channel values.

Hopping Channel Mode: HP Parameter value range is 0 through 6

Single Frequency Channel Mode: HP range is 0 through 0x18 (decimal range: 0 – 24)

In "Hopping Channel Mode", each channel utilizes a different pseudo-random hopping sequence to navigate through shared hopping channels. In the event that two modules from different networks collide on a channel, the two modules will jump to separate channels on the next hop. Multiple module pairs can operate in the same vicinity with minimal interference from each other.

Destination Address (ATDT) and Address Mask (ATMK)

XCite Destination Addresses and Masks provide the means to set up global or local addresses for establishing module groups, subnets, etc. The Destination Address network layer provides for more granular isolation of radio modems. The XCite Destination Addresses and Masks can be used to:

- Set up point-to-point and point-to-multipoint network configurations
- Provide greater flexibility in establishing module groups, subnets, etc.

Each radio modem in a network can be configured with a 16-bit Destination Address to establish selective communications within a network. This address is set to one of 65535 values using DT (Destination Address) Command. The default Destination Address is 0.

All radio modems with the same Destination Address can transmit and receive data among themselves. Radio modems having different Destination Addresses still detect and listen to the data (in order to maintain network synchronization); however, the data is discarded rather than passing on through the DO pin.

Packet-based Radio Modems

XCite Radio Modems are packet based. This means all data shifted into one module is packetized and sent out the antenna port. Because XCite modules use a peer-to-peer architecture, all modules on the same channel (ATHP) will receive the packet and decide whether to pass it to the host or to throw it away. Each transmitted packet contains information about the transmitting module.

Any module that receives a packet will check the address values and decide what to do with the packet. The options are as follows:

- Receive the packet as a global packet
- Receive the packet as a local packet
- Discard the packet

Address Mask

The mask parameter can be used to allow a base module to receive data from a range of addresses. It may also be used to configure "subnets" of modules that communicate in a group together.

See below for the Pseudo 'C' Code that qualifies the Destination Addresses and address masks.

The Pseudo Code uses the bit-wise "AND" operation, "&". This operation is performed bit by bit on each of the 16 bits in the TXDT, RXDT and RXMK parameters.

Table 8. Bit-wise AND Truth

Bit-wise AND Operation ("&")		
Operand 1	& Operand 2	= Result
0	0	0
0	1	0
1	0	0
1	1	1

For example: Hexadecimal: 0x3 & 0x9 = 0x1

The Address Mask can be used as an additional method of facilitating communications between modules. The Address Mask can be set to one of 65535 possible values using MK (Address Mask) Command. The default value of the MK Parameter is 0xFFFF.

All transmitted data packets contain the Destination Address of the transmitting module. When a transmitted packet is received by a module, the Destination Address of the transmitter (contained in the packet) is logically "ANDed" (bitwise) with the Address Mask of the Receiver. If the resulting value matches the Destination Address of the Receiver, or if it matches the Receiver Address Mask, the packet is accepted. Otherwise, the packet is discarded.

Note: When performing this comparison, any "0" values in the Receiver Address Mask are treated as irrelevant and are ignored.

Pseudo code for receiving

```

/* *****
* Function: Receive_Data()
*
* Description: Algorithm used by XCite modules
*              to qualify incoming data packets.
*
* Variables:
* (parameter types: short = 16 bits, char = 8 bits)
*
*   short TXDT = Transmitter's Module Address (ATDT)
*   short RXDT = Receiver's Module Address (ATDT)
*   short RXMK = Receiver's Module Address Mask (ATMK)
*
* *****/

Function Receive_Data (TXDT, RXDT, RXMK, RXRR)
{
  if((TXDT & RXMK) == RXMK) /* Is incoming address a global address? */
  {
    Send_data_out_port(); /* Call to function that Sends data out port */
  }

  else if((TXDT & RXMK) == (RXDT & RXMK)) /* Is TXDT a local address? */
  {
    Send_data_out_port(); /* Call to function that Sends data out port */
  }

  else /* neither global nor local address */
  {
    Purge_buffer(); /* Call to some function that throws data away */
  }
} /* End Function Receive_Data() */

```

Pseudo code for transmitting

```

/* *****
* Function: RF_Transmit_Control ()
*
* Description: Algorithm used by XCite modules
*              to packetize and transmit data packets.
*              This procedure only runs if there is
*              data in the data buffer and the
*              communication channel is clear.
*
* Variables:
* (parameter types: short = 16 bits, char = 8 bits)
*
*   char DINC = Number of bytes in Data In Buffer
*
* *****/

Function RF_Transmit_Control (DINC)
{
  Initialize_RF_Channel (); /* This process takes 35ms */
  while(DINC > 0) /* Data In Buffer is not empty */
  {
    Assemble_RF_Packet (); /* Packet contains TXDT, TXVD and TXHP params*/
    {
      Transmit_Data (); /* Call function that shifts data out antenna */
    } /* Global packets not subject to TXRR */

  } /* End while Data In Buffer is not empty */

  Close_RF_Channel (); /* Allows other modules to communicate */
} /* End Function RF_Transmit_Control () */

```

Appendix A: FCC Certifications

FCC Compliance

The MaxStream XCite OEM RF Module complies with Part 15 of the FCC Rules. Compliance requires the following be stated:

Contains FCC ID: OUR-9XCITE

The enclosed device complies with Part 15 of the FCC Rules. Operation is subject to the following two conditions: (1) this device may not cause harmful interference and (2) this device must accept any interference received, including interference that may cause undesired operation.

OEM Labeling Requirements

Label Warning



WARNING The Original Equipment Manufacturer (OEM) must ensure that FCC labeling requirements are met. This includes a clearly visible label on the outside of the final product enclosure that displays the contents shown in the figure below.

Figure 22. Required FCC Label for OEM products containing XCite OEM RF Module

Contains FCC ID: OUR-9XCITE
The enclosed device complies with Part 15 of the FCC Rules. Operation is subject to the following two conditions: (1) this device may not cause harmful interference and (2) this device must accept any interference received, including interference that may cause undesired operation.

FCC Notices

Adherence to the following is required:

IMPORTANT: The XCite (900 MHz) OEM Module has been certified by the FCC for use with other products without any further certification (as per FCC section 2.1091). Changes or modifications not expressly approved by MaxStream could void the user's authority to operate the equipment.

IMPORTANT: OEMs must test their final product to comply with unintentional radiators (FCC section 15.107 and 15.109) before declaring compliance of their final product to Part 15 of the FCC Rules.

IMPORTANT: The XCite OEM RF Module has been certified for remote and base radio applications. If the XCite will be used for portable applications, the device must undergo SAR testing.

NOTE:

This equipment has been tested and found to comply with the limits for a Class B digital device, pursuant to Part 15 of the FCC Rules. These limits are designed to provide reasonable protection against harmful interference in a residential installation. This equipment generates, uses and can radiate radio frequency energy and, if not installed and used in accordance with the instructions, may cause harmful interference to radio communications. However, there is no guarantee that interference will not occur in a particular installation. If this equipment does cause harmful interference to radio or television reception, which can be determined by turning the equipment off and on, the user is encouraged to try to correct the interference by one or more of the following measures:

- Reorient or relocate the receiving antenna.
- Increase the separation between the equipment and receiver.
- Connect the equipment into an outlet on a circuit different from that to which the receiver is connected.
- Consult the dealer or an experienced radio/TV technician for help.

9XCite (900 MHz) Approved Antennas

ANTENNA WARNING



WARNING This device has been tested with Reverse Polarity SMA connectors with the antennas listed in the table below. When integrated into the OEM product, these fixed antennas require installation preventing end-users from replacing them with non-approved antennas. Any antenna not already tested with the XCite module must be tested to comply with FCC Section 15.203 for unique antenna connectors and Section 15.247 for emissions.

Table 9. Antennas approved for use with the 9XCite (900 MHz) OEM RF Module

Part Number	Type	Gain	Application
*	Yagi	6.2dBi	Fixed/Mobile **
*	Yagi	7.2dBi	Fixed/Mobile **
A09-Y8	Yagi	8.2dBi	Fixed/Mobile **
	Yagi	9.2dBi	Fixed/Mobile **
	Yagi	10.2dBi	Fixed/Mobile **
A09-Y11	Yagi	11.2dBi	Fixed/Mobile **
	Yagi	12.2dBi	Fixed/Mobile **
	Yagi	13.2dBi	Fixed/Mobile **
	Yagi	14.2dBi	Fixed/Mobile **
A09-Y15	Yagi	15.2dBi	Fixed/Mobile **
A09-F2	Omni Direct	2.2dBi	Fixed **
A09-F5	Omni Direct	5.2dBi	Fixed **
A09-F8	Omni Direct	8.2dBi	Fixed **
*	Omni Direct	9.2dBi	Fixed **
*	Omni Direct	7.2dBi	Fixed **
A09-M7	Omni Direct	7.2dBi	Fixed **
A09-H	1/2 wave antenna	2.1dBi	Fixed/Mobile **
A09-HBMM-P5I	1/2 wave antenna	2.1dBi	Fixed/Mobile **
A09-QBMM-P5I	1/4 wave antenna	1.9 dBi	Fixed/Mobile **
*	1/4 wave integrated wire antenna	1.9 dBi	Fixed/Mobile **

* FCC-approved antennas not inventoried by MaxStream – Contact MaxStream for more information.

** Can be approved for portable applications if integrator gains approval through SAR testing

Over 100 additional antennas that have been tested and are approved for use with MaxStream 900 MHz Radio Modems (including “Mag Mount”, “Dome”, “Multi-path” and “Panel” antennas). Because of the large number of approved antennas, MaxStream requests that you send specific information about an antenna you would like to use with the modem and MaxStream will evaluate whether the antenna is covered under our FCC filing.

Contact MaxStream (801) 765-9885 for more information.

In addition to the antennas listed in Table 7, over 100 additional antennas have been tested and approved for use with the XCite module. Contact MaxStream toll-free (1-866-765-9885) for a complete list that includes “Mag Mount”, “Dome”, “Multi-path” and “Panel” antennas.

RF EXPOSURE



WARNING For Portable Antenna Applications: The antenna(s) used for this transmitter must be installed to provide a separation distance of at least 20 cm from all persons and must not be co-located or operating in conjunction with any other antenna or transmitter for satisfying RF exposure compliance.

The preceding statement must be included as a CAUTION statement in manuals for OEM products to alert users on FCC RF Exposure compliance.

Appendix B:

Additional Information

XCite OEM RF Module Specifications

Table 10. XCite OEM Module Specifications

Specification	9XCite (900 MHz) OEM RF Module	
Performance		
Indoor/Urban Range	up to 300' (90 m)	
Outdoor LOS Range	up to 1000' (300 m) w/ 2.1 dB dipole antenna	
Transmit Power Output	4 mW (6 dBm)	
Interface Data Rate	Software selectable 1200-57600 bps	
Throughput Data Rate	9600 bps	38400 bps
RF Data Rate (Baud)	10000 bps	41666 bps
Receiver Sensitivity	-108 dBm	-104 dBm
Interfacing, Networking & Security		
Frequency	902-928 MHz	
Spread Spectrum Type	Frequency Hopping, Direct FM modulator	
Single Channel (Optional)	Fixed or User Selectable (up to 12 channels)	
Network Topology	Peer-to-Peer, Point-to-Multipoint, Point-to-Point, Multi-Drop Transparent	
Channel Capacity	Hopping Mode (7 hop sequences share 25 frequencies) or Single Channel Mode (25 single frequency channels)	
Serial Data Interface	CMOS	
Power Requirements		
Supply Voltage	2.85 to 5.50 VDC	
Transmit Current (@ 2.85V)	55 mA	
Receive Current (@ 2.85V)	45 mA	
Receive Current (@ 5V)	55 mA	
Power Down Current	20 µA	
Physical Properties		
Module Board Size	1.6" x 2.825" x 0.35" (4.06 cm x 7.17 cm x 0.89 cm)	
Weight	0.8 oz. (24 g)	
Connector	11-Pin & 4-Pin 0.1" spaced Male Berg-type headers	
Operating Temperature	Commercial (0 to 70° C) or Industrial (-40 to 85° C)	
Antennas		
Type	¼ Wave Monopole, 3" (7.62 cm) integrated wire, 1.9 dBi	
Connector (Optional)	Reverse-polarity SMA (RPSMA)	
Impedance	50 ohms unbalanced	
Certifications (For complete list, visit www.MaxStream.net or call 1-801-765-9885)		
FCC Part 15.247	OUR-9XCITE	
Industry Canada (IC)	4214A-9XCITE	

1-Year Warranty

The XCite (900 MHz) OEM RF Module from MaxStream, Inc. (the "Product") is warranted against defects in materials and workmanship under normal use, for a period of 1-year from the date of purchase. In the event of a product failure due to materials or workmanship, MaxStream will repair or replace the defective product. For warranty service, return the defective product to MaxStream, shipping prepaid, for prompt repair or replacement. The foregoing sets forth the full extent of MaxStream's warranties regarding the Product. Repair or replacement at MaxStream's option is the exclusive remedy. THIS WARRANTY IS GIVEN IN LIEU OF ALL OTHER WARRANTIES, EXPRESS OR IMPLIED, AND MAXSTREAM SPECIFICALLY DISCLAIMS ALL WARRANTIES OF MERCHANTABILITY OR FITNESS FOR A PARTICULAR PURPOSE. IN NO EVENT SHALL MAXSTREAM, ITS SUPPLIERS OR LICENSORS BE LIABLE FOR DAMAGES IN EXCESS OF THE PURCHASE PRICE OF THE PRODUCT, FOR ANY LOSS OF USE, LOSS OF TIME, INCONVENIENCE, COMMERCIAL LOSS, LOST PROFITS OR SAVINGS, OR OTHER INCIDENTAL, SPECIAL OR CONSEQUENTIAL DAMAGES ARISING OUT OF THE USE OR INABILITY TO USE THE PRODUCT, TO THE FULL EXTENT SUCH MAY BE DISCLAIMED BY LAW. SOME STATES DO NOT ALLOW THE EXCLUSION OR LIMITATION OF INCIDENTAL OR CONSEQUENTIAL DAMAGES. THEREFOR, THE FOREGOING EXCLUSIONS MAY NOT APPLY IN ALL CASES. This warranty provides specific legal rights. Other rights which vary from state to state may also apply.

XCite OEM RF Module Part Numbers

Figure 23. Part Numbers Key

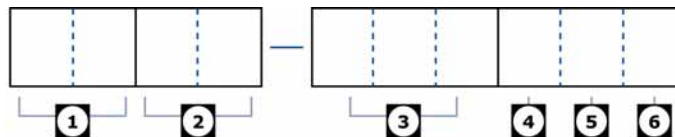

Divisions of the XCite OEM RF Module part number:

1 MaxStream Product Family
 XC = XCite
 X = XStream

2 Operating Frequency
 09 = 902-928 MHz

3 RF Data Rate (Baud)
 009 = 9600 Baud
 038 = 38400 Baud

4 Wire Antenna
 W = Wire Antenna
 N = No Wire Antenna

5 Connector
 S = RPSMA Connector
 N = No Connector

6 Module Temperature Rating
 C = Commercial: 0 to 70° C
 I = Industrial: -40 to 85° C, conformal coated
 T = Tested: -40 to 85° C, conformal coating & 100% tested

For example: XC09-038NSC

(9XCite Module, 900 MHz, 38400 Baud, No Wire Antenna, RPSMA Connector, Commercial Temperature Rating)

Appendix C: Troubleshooting & FAQs

Contact MaxStream

Free and unlimited technical support is included with every MaxStream Radio Modem sold.

Please use the following resources for additional support:

Documentation:	www.maxstream.net/helpdesk/
Technical Support:	Phone. (866) 765-9885 U.S. & Canada (801) 765-9885 Worldwide
	Live Chat. www.maxstream.net
	E-Mail. rf-xperts@maxstream.net

MaxStream office hours are 8:00 am – 5:00 pm [U.S. Mountain Standard Time]