

FC9Y-B919

**MICROSmart**



**FC4A SERIES**

**MICRO**S**mart**

**Web Server Unit**

**Instruction Manual**

# PRECAUTIONS

- Read this user's manual to make sure of correct operation before starting installation, wiring, operation, maintenance, and inspection of the MicroSmart modules.
- All MicroSmart modules are manufactured under IDEC's rigorous quality control system, but users must add a backup or failsafe provision to the control system using the MicroSmart in applications where heavy damage or personal injury may be caused in case the MicroSmart should fail.
- In this user's manual, safety precautions are categorized in order of importance to Warning and Caution.

## WARNING

Precautions on hazards that could result in death or serious injury if equipment is handled incorrectly.

## CAUTION

Precautions on hazards that could result in injury or equipment damage if equipment is handled incorrectly.

## WARNING

- Turn off the power to the MicroSmart before starting installation, removal, wiring, maintenance, and inspection of the MicroSmart. Failure to turn power off may cause electrical shocks or fire hazard.
- Special expertise is required to install, wire, program, and operate the MicroSmart. People without such expertise must not use the MicroSmart.
- Emergency stop and interlocking circuits must be configured outside the MicroSmart. If such a circuit is configured inside the MicroSmart, failure of the MicroSmart may cause disorder of the control system, damage, or accidents.
- Install the MicroSmart according to the instructions described in this user's manual. Improper installation will result in falling, failure, or malfunction of the MicroSmart.

## CAUTION

- The MicroSmart is designed for installation in a cabinet. Do not install the MicroSmart outside a cabinet.
- Install the MicroSmart in environments described in this user's manual. If the MicroSmart is used in places where the MicroSmart is subjected to high-temperature, high-humidity, condensation, corrosive gases, excessive vibrations, and excessive shocks, then electrical shocks, fire hazard, or malfunction will result.
- The environment for using the MicroSmart is "Pollution degree 2". Use the MicroSmart in environments of pollution degree 2 (according to IEC 60664-1).
- Prevent the MicroSmart from falling while moving or transporting it, otherwise damage or malfunction of the MicroSmart will result.
- Prevent metal fragments and pieces of wire from dropping inside the MicroSmart housing. Put a cover on the MicroSmart modules during installation and wiring. Ingress of such fragments and chips may cause fire hazard, damage, or malfunction.
- Use a power supply of the rated value. Use of a wrong power supply may cause fire hazard.
- Use an IEC 60127-approved fuse on the power line outside the MicroSmart. This is required when equipment containing the MicroSmart is destined for Europe.
- Use an IEC 60127-approved fuse on the output circuit. This is required when equipment containing the MicroSmart is destined for Europe.
- Use an EU-approved circuit breaker. This is required when equipment containing the MicroSmart is destined for Europe.
- Make sure of safety before starting and stopping the MicroSmart or when operating the MicroSmart to force outputs on or off. Incorrect operation on the MicroSmart may cause machine damage or accidents.
- Do not connect the ground wire directly to the MicroSmart. Connect a protective ground to the cabinet containing the MicroSmart using an M4 or larger screw. This is required when equipment containing the MicroSmart is destined for Europe.
- Do not disassemble, repair, or modify the MicroSmart modules.
- Dispose of the battery in the MicroSmart modules when the battery is dead in accordance with pertaining regulations. When storing or disposing of the battery, use a proper container prepared for this purpose. This is required when equipment containing the MicroSmart is destined for Europe.
- When disposing of the MicroSmart, do so as an industrial waste.

# INTRODUCTION

---

Thank you for your purchase of the IDEC Izumi Web Server Unit.

This manual contains the specifications of the Web Server Unit (MicroSmart communication module), and describes how to use the unit.

Before using the unit, read this manual to thoroughly familiarize yourself with this product's functions and performance, and to ensure correct operation.

## Important

1. Unauthorized reproduction, reprinting, sale, transfer or lending of this manual in whole or part is strictly prohibited.
2. The contents of this manual are subject to change without prior notice.
3. Every effort has been taken to ensure the accuracy of the information contained in this manual. However, if you do discover an error or omission, report it to your place of purchase or nearest IDEC Izumi sales office or branch.

- WindLDR is a registered trademark of IDEC Izumi Corporation.
- Microsoft® Windows® and Microsoft® Internet Explorer are registered trademarks or trademarks of Microsoft Corporation (US) in the US and other countries.
- Java and all the trademarks and logos related to Java are registered trademarks or trademarks of Sun Microsystems, Inc. (US) in the US and other countries.
- Netscape, Netscape Navigator and Netscape's N logo are registered trademarks of Netscape Communications Corporation in the US and other countries. Netscape's logo, Netscape Communicator and other product/service names are trademarks (or registered trademarks in some countries) of Netscape Communications Corporation. Copyrights of Netscape Navigator are reserved by Netscape Communications Corporation.
- Ethernet is a trademark of Xerox Corporation USA.
- Other company names and product names shown in this manual are trademarks or registered trademarks of each company.

# REVISION HISTORY

---

The revision history of this manual (FC9Y-B919) is shown below.

<b>Date of revision</b>	<b>Documentation control No.</b>	<b>Description</b>
June 2005	B919-(0)	First edition

This manual's documentation control No. is printed at the back cover.

# TABLE OF CONTENTS

---

Precautions  
Introduction  
Revision History  
Table of Contents

---

## CHAPTER 1: Overview ..... 1-1

---

1 Web Server Unit Overview ..... 1-2

---

## CHAPTER 2: Specifications ..... 2-1

---

1 Names and Specifications of Module Components ..... 2-2

2 Performance Specifications ..... 2-3

---

## CHAPTER 3: Module Operation ..... 3-1

---

1 Web Server Unit Settings ..... 3-2

2 Remote Maintenance Function ..... 3-10

3 Web Server Function ..... 3-14

4 Ethernet User Communication Function ..... 3-21

5 Mail Sending Function ..... 3-29

Connection Diagram  
Troubleshooting  
Glossary  
Index

# CHAPTER 1

# OVERVIEW

---

This chapter provides an overview of the Web Server Unit.

# Web Server Unit Overview

This section provides an overview of the Web Server Unit.

## ■ Applications

The Web Server Unit has following four major functions.

Remote Maintenance Function	The remote maintenance function using MicroSmart.
Web Server Function	The remote monitoring function using Web browser.
Ethernet User Communication Function	The communication function between MicroSmart modules.
Mail Sending Function	The mail sending function from MicroSmart.

## ■ Functions

### ● Remote Maintenance Function

Using the Web Server Unit and WindLDR version 4.70 (or a later version) enables Ethernet-based MicroSmart ladder program reading/writing and operand read/write operations.

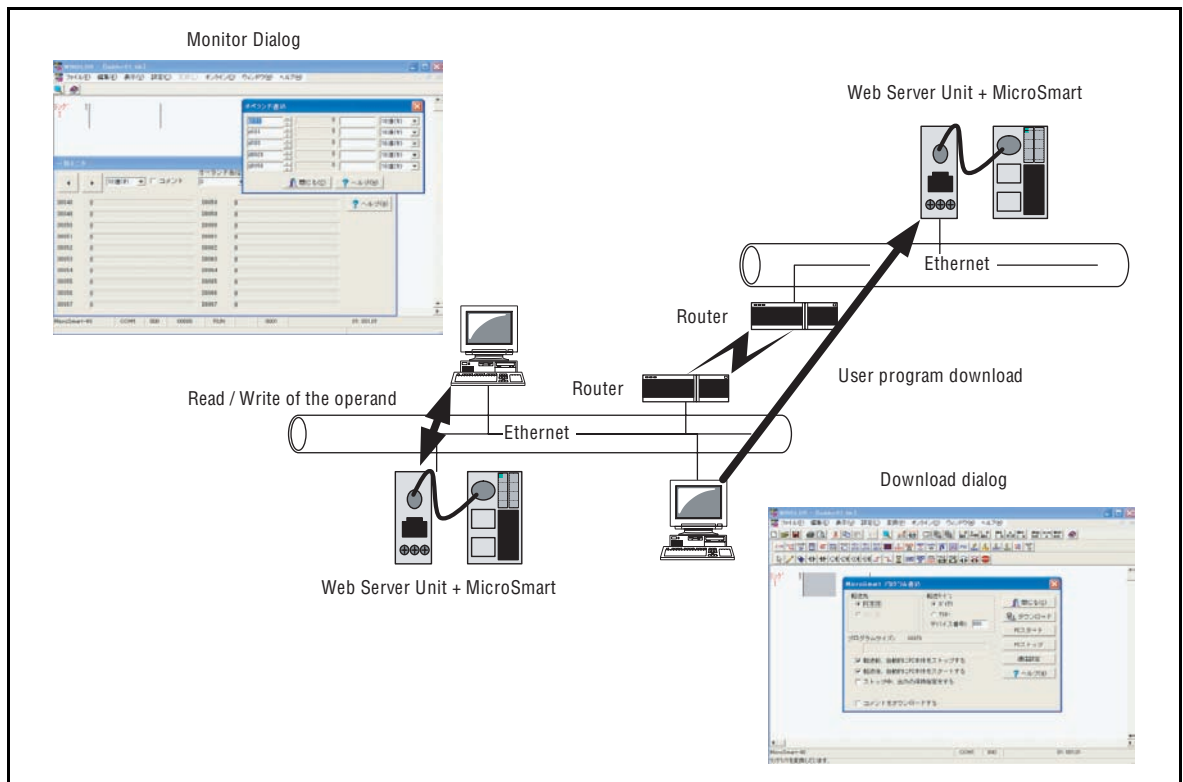

Block diagram of remote maintenance (WindLDR)

● **Web Server Function**

The Web server's sample screens or user creation screens enable MicroSmart operand read/write operations from a Web browser.

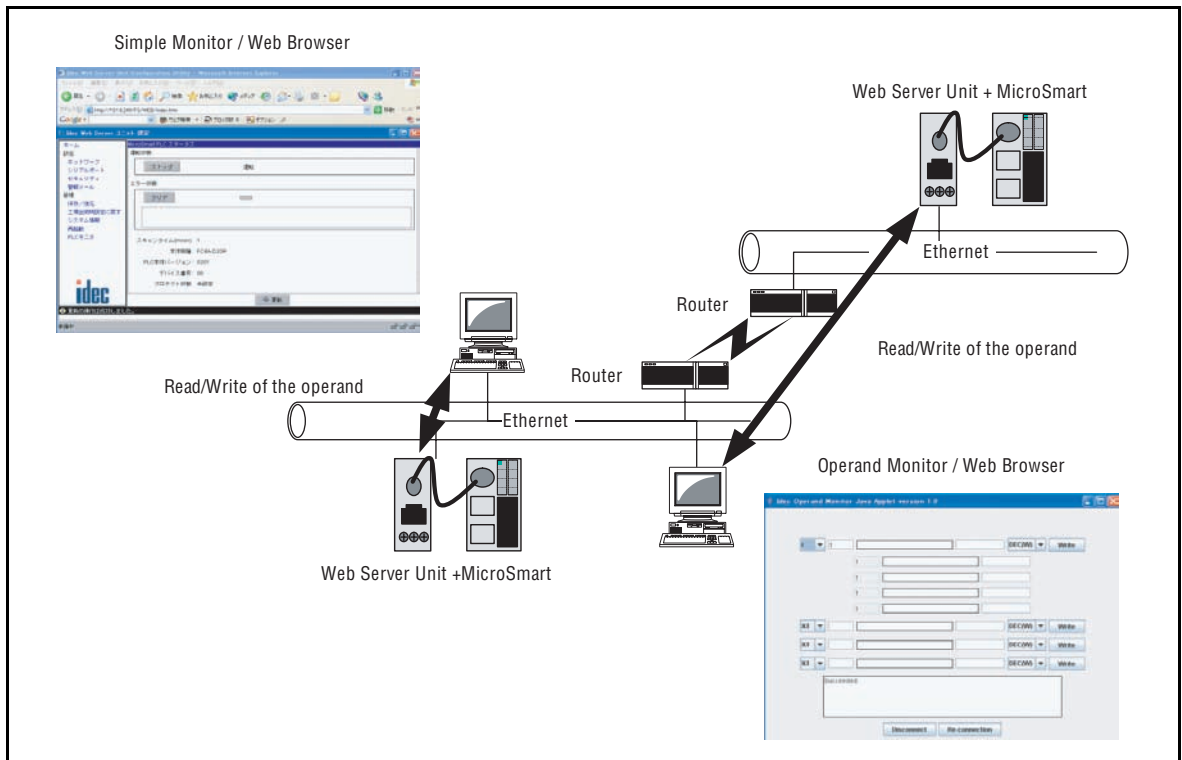

Block diagram of remote monitoring (Web browser)

● **Ethernet User Communication Function**

The Web Server Unit function and MicroSmart user communication commands enable Ethernet-based 1:1 communication between MicroSmart modules.

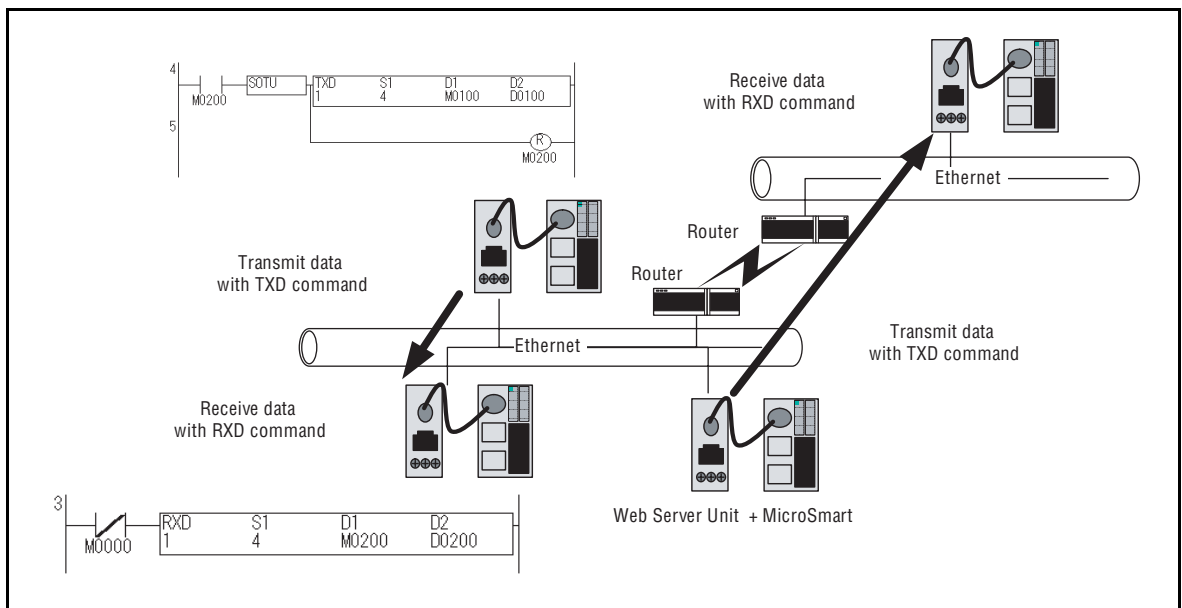

Block diagram of communication between MicroSmart modules

## ● Message Sending Function

The Web Server Unit function and MicroSmart user communication commands enable message (mail) sending to a PC or mobile phone.

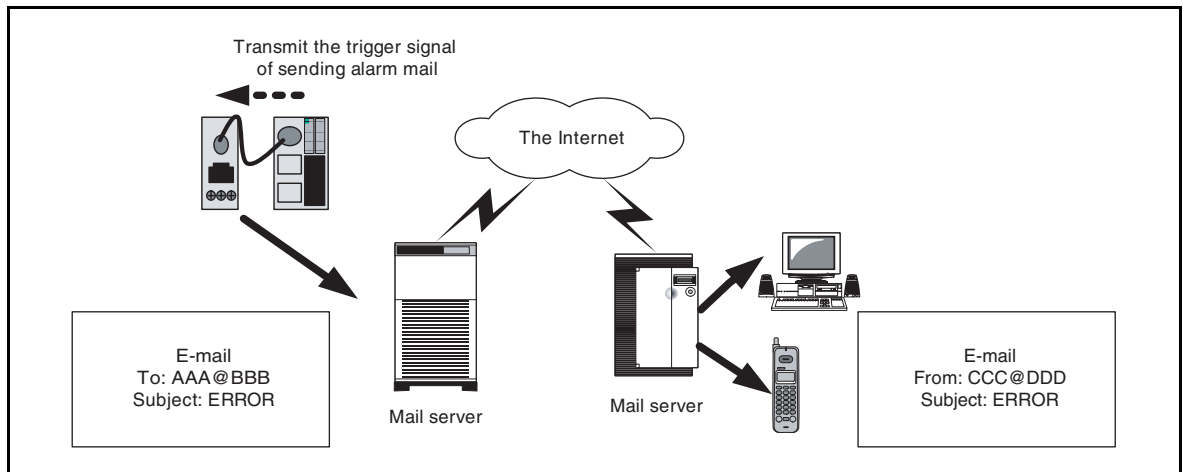

Block diagram of mail transmission

## ■ Network Cautions

### ● Caution when connecting

The Web Server Unit has to be used on the local network. When accessing the PLC via network using the Web Server Unit function, it takes time to transfer the data in some communication environments. Be sure to set the timeout value in the PLC communication settings.

As regards the network connection, please consult with the network administrator.

### ● Security Caution

The Web Server Unit's user name and password authentication function will not completely prevent unauthorized access.

### ● Limitation on User Screen Creation

User screen sample pages are provided, but knowledge of Java applets is needed to modify sample screens to create original pages. See the Sun Microsystems Inc. web site for more information on Java applets.

# CHAPTER 2

# SPECIFICATIONS

---

This chapter contains information on the Web Server Unit's specifications. Familiarize yourself with the information in this chapter to ensure effective use of the Web Server Unit.

## Names and Specifications of Module Components

This section provides the names and specifications of Web Server Unit components.

### Names

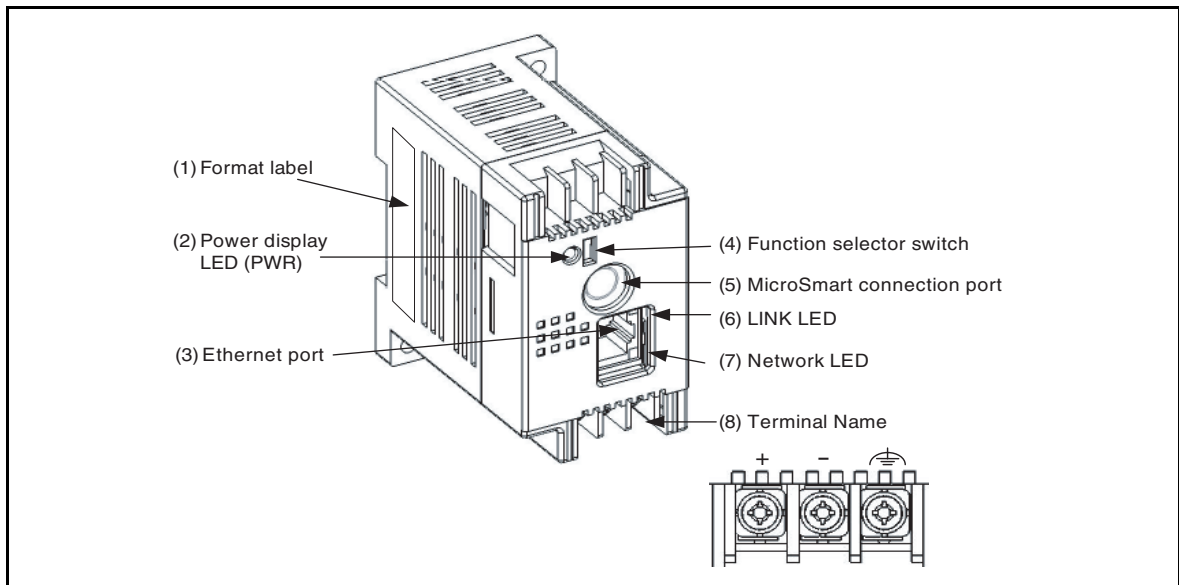

System configuration diagram

- 1) **Format label**  
Indicates the Web Server Unit model No./type.
- 2) **Power display LED ; Green (PWR)**  
Lights when power is being supplied to the Web Server Unit.
- 3) **Ethernet port**  
The port into which the ends (RJ-45) of the Ethernet cable is inserted.
- 4) **Function selector switch**  
Used to switch the Web Server Unit's function.  
When using the remote maintenance function and the Web server function, set the switch to "REMOTE".  
When using the Ethernet user communication function and the mail sending function, set the switch to "USER".  
\*The default setting is "REMOTE".
- 5) **MicroSmart connection port**  
Serial communication port connecting the Web Server Unit and MicroSmart.
- 6) **LINK LED**  
Lights when the cable is connected to the Web Server Unit.
- 7) **Network LED**  
Flashes when the Web Server Unit is sending/receiving data.
- 8) **Terminal name**  
Indicates the terminal name.

## Performance Specifications

This section provides the Web Server Unit's performance specifications.

### ■ General Specifications

#### ● Normal Operating Conditions

<b>Model type</b>		<b>FC4A-SX5ES1E</b>
<b>Operating Temperature</b> (Operating ambient temperature)		0 to 55°C
<b>Storage Temperature</b>		-25 to +70°C (non-freezing)
<b>Relative Humidity</b>		10 to 95% (non-condensing)
<b>Pollution Degree</b>		2 (IEC60664-1)
<b>Degree of Protection</b>		IP20 (IEC60529)
<b>Corrosion Immunity</b>		Free from corrosive gases
<b>Altitude</b>		Operation: 0 to 2,000m (0 to 6,565 feet) Transport: 0 to 3,000m (0 to 9,840 feet)
<b>Vibration Resistance</b>	<b>When mounted on a DIN rail:</b>	5 to 9Hz amplitude 3.5mm, 9 to 150Hz acceleration 9.8m/sec <sup>2</sup> 2 hours per axis on each of three mutually perpendicular axes (IEC61131-2)
	<b>When mounted on a panel surface:</b>	
<b>Shock Resistance</b>		147m/sec <sup>2</sup> (15G) 11msec duration, on three mutually perpendicular axes (IEC61131-2)
<b>Antistatic discharger</b>		Contact: ±6kV, Aerial: ±8kV (IEC61000-4-2)

#### ● Power Supply

<b>Rated Power Voltage</b>	24V DC		
<b>Allowable Momentary Power Interruption</b>	Greater than or equal to 10msec (at 24V DC)		
<b>Dielectric strength</b>	Between power and terminal	500V AC	1 minutes
<b>Insulation resistance</b>	Between power and terminal	Greater than or equal to 10MΩ (500V DC megger)	
<b>Noise Resistance</b>	DC power terminals	1.0kV, 50nsec to 1μsec (Direct connecting)	
	Ethernet cable	0.5kV, 50nsec to 1μsec (Coupling clamp)	
<b>Grounding</b>	100Ω		
<b>Grounding wire</b>	UL1007 AWG16		
<b>Power Supply Wire</b>	UL1015 AWG22, UL1007 AWG18		
<b>Effect of Improper Power Supply Connection</b>	Reverse polarity	No operation, no damage	
	Improper voltage or frequency	Permanent damage may be caused	
	Improper lead connection	Permanent damage may be caused	
<b>Weight</b>	120g		

● **Communication Functions**

<b>Serial</b>	
<b>Standards</b>	Compatible with the EIA RS232C standard
<b>Baud Rate</b>	9,600bps (Default) to 115,200bps
<b>Synchro system</b>	Asynchronous communication method
<b>Transmission method</b>	Full duplex
<b>Ethernet</b>	
<b>Standards</b>	Compatible with the IEEE802.3 standard
<b>Transmission rate</b>	10BASE-T
	100BASE-TX (Out of the standard coverage) <sup>*1</sup>
<b>Communication protocol</b>	IP/ICMP/ARP/TCP <sup>*2</sup> /SMTP/HTTP/Telnet

\*1. Depending on the noise environments, Web Server Unit cannot communicate on the 100BASE-TX in some cases.

\*2. The number of unit to be connected at the same moment is one unit.

● **Functions**

<b>Web Server</b>	
<b>Supported Web Browser</b>	Internet Explorer 6.0 or later
	Netscape Navigator 7.2 or later
<b>Java VM</b>	Versions 1.42 or later
<b>Alarms</b>	
<b>Alarm contents</b>	Alarm contents have to be registered in the Web Server Unit in advance.
<b>The number of alarm types</b>	32 types
<b>Alarm character strings</b>	Within 63 characters (1 byte character)
<b>The number of destination addresses</b>	2 addresses (The sum of two address characters is up to 64 characters)

● **Connectable Unit**

<b>PLC <sup>*1</sup></b>	FC2A series <sup>*2</sup> , FC3A series, FC4A series
<b>Programmable Display <sup>*3,*4</sup></b>	HG2F <sup>*5</sup>

\*1. The PLC requires the connecting cable type, FC4A-KC3C, to connect to the Web Server Unit.

\*2. Except for Micro<sup>3</sup> in FC2A series.

\*3. The programmable display requires the connecting cable type, HG9Z-3C125, to connect to the Web Server Unit.

\*4. The programmable display requires the firmware versions 1.8 or later.

\*5. Please contact IDEC for more detail.

# CHAPTER 3

# MODULE OPERATION

---

This chapter provides an overview of the operation method, and contains information on parameters and sample programs. Familiarize yourself with the information in this chapter to ensure effective use of the Web Server Unit.

## Web Server Unit Settings

This section describes how to set the Web Server Unit.

### ■ Setting Procedure

The following settings are needed to connect the Web Server Unit to Ethernet and operate its functions.

- System Configuration
- System Setting Screen
- Network Address Setting Procedure
- Serial Communication Setting Procedure
- Other Function Settings
  - 1) Security
  - 2) Mail Sending
  - 3) Administration

### ● System Configuration

Use the following either methods to connect the Web Server Unit to a PC\* with WindLDR version 4.70 (or a later version) installed.

- (1) The connection using a Hub and Ethernet straight cables
- (2) The connection using an Ethernet cross cable

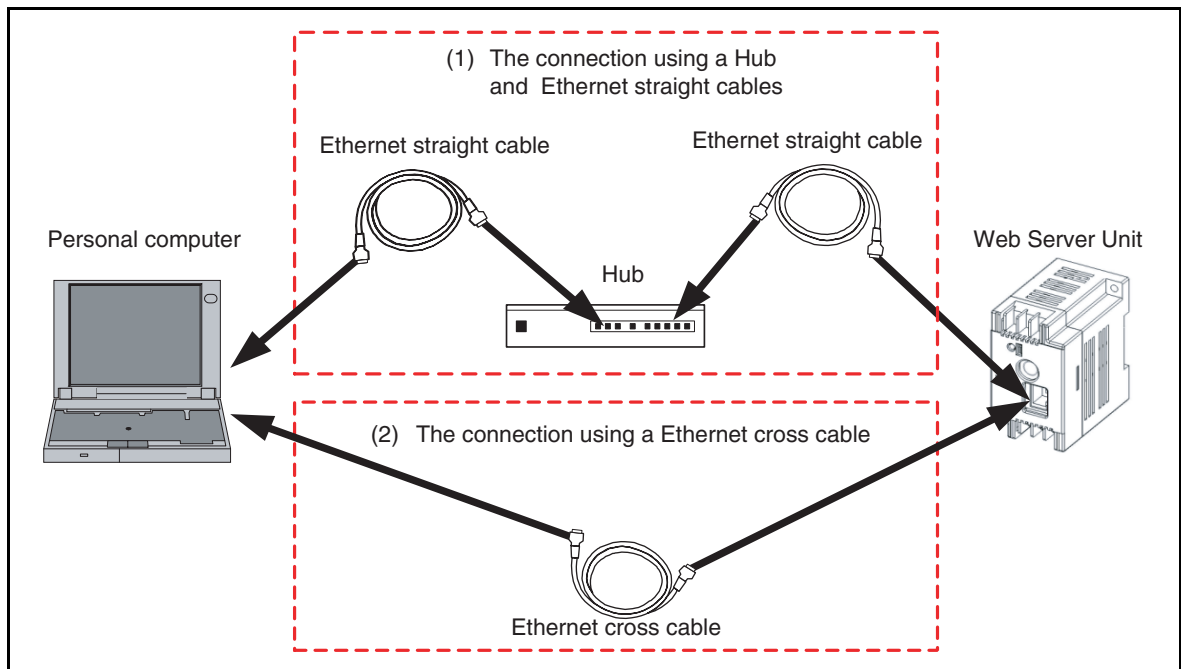

Connection methods

- \* Make sure an IP address is set for the PC. To initialize Web Server Unit from the factory default state, it is necessary to connect the personal computer and the Web Server Unit by the same network setting. Because the factory default IP address for the Web Server Unit is [192.168.1.5], the IP address of Personal Computer have to be [192.168.1.1] for instance.
- \* The PC must be able to run a Web browser (such as Internet Explorer). Enable JavaScript and Java applets.
- \* When connecting to a network such as a company LAN, consult the network administrator before connecting the Web Server Unit.

● **System Setting Screen**

1. Select [Configure]→[Communication Settings]→[Ethernet] from the WindLDR menu and press [OK]. Then select [Setting Web Server Unit]. \*This time, the correct PLC have to be selected on the [Configure]→[PLC Selection].

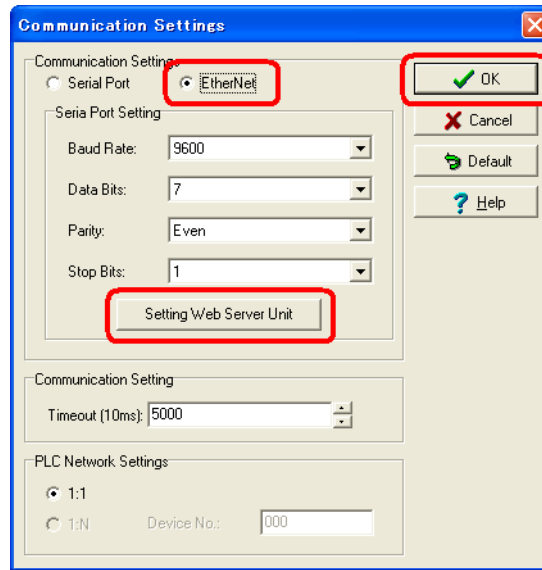

WindLDR dialog

2. By pressing the [Search] button, the list of the Web Server Unit information appears in the WindLDR screen. Or otherwise, using the [Add] button enter the IP address and add the item for the list. Then select the communication target from the list and press [OK].

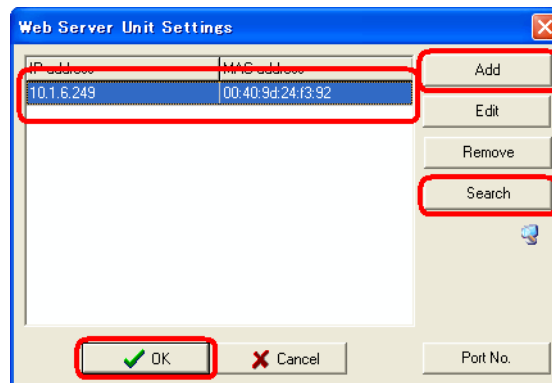

WindLDR dialog

3. A warning dialog appears asking whether to start the applet. Select [Yes] or [Always]. When you select [Always], the dialog does not appear the next time you start the Web browser. Java applet is loaded.

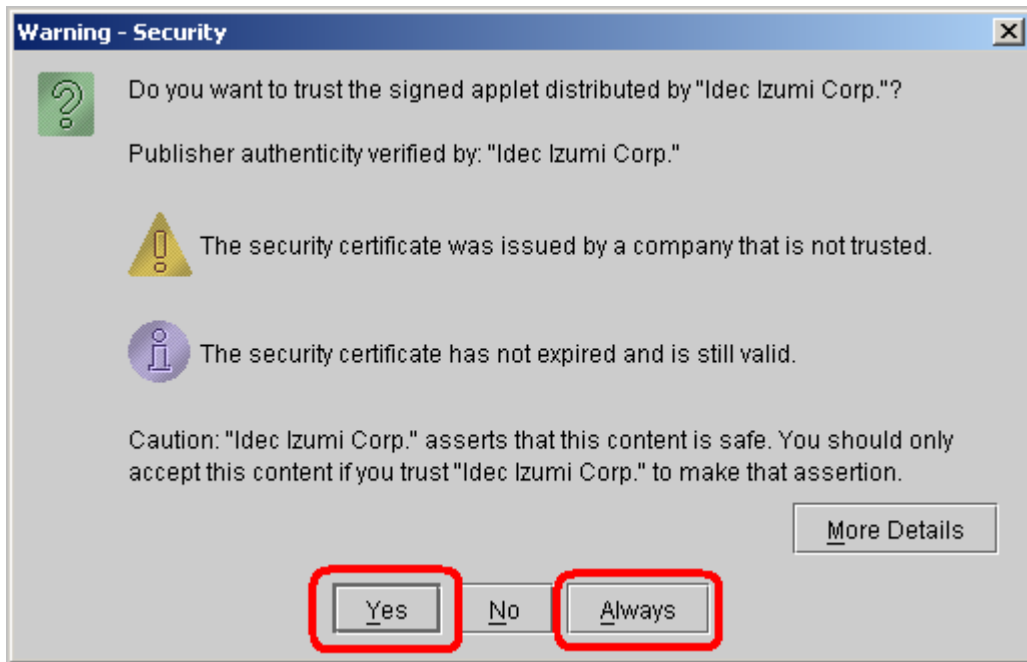

Warning dialog during Java applet startup

4. The System Setting Screen below appears. Use it to make the settings.

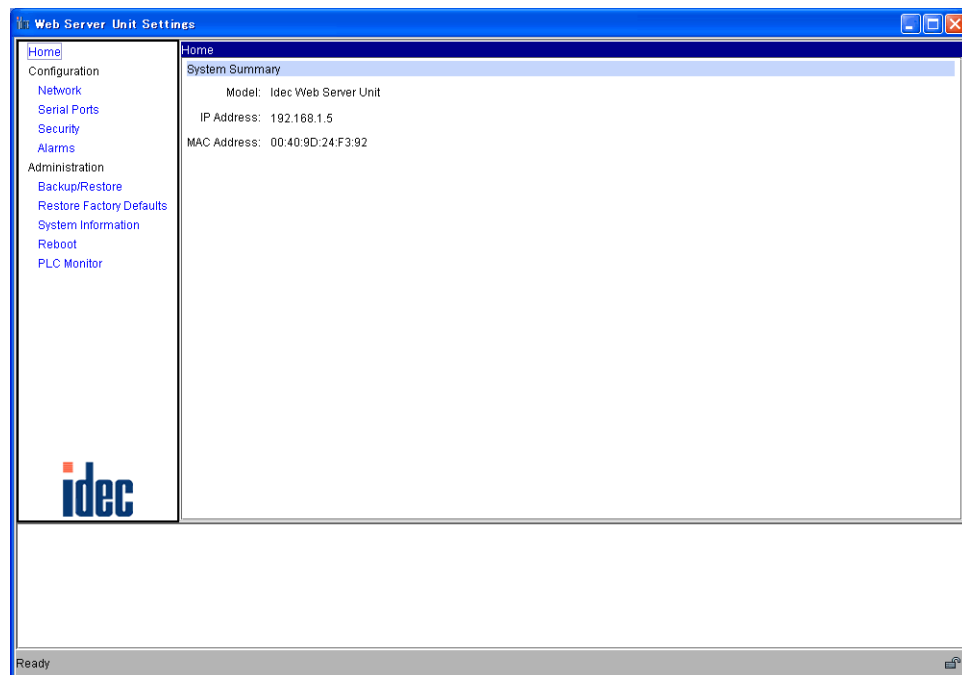

System Setting Screen

The following settings are available in the System Setting Screen.

Menu	Description
HOME	Initial screen when the system startups. Model, IP address and MAC address are displayed.
<b>Configuration</b>	
Network	Network settings
Serial Ports	Serial port settings
Security	Password settings
Alarms	Message settings
<b>Administration</b>	
Backup/Restore	Saves and backups the set values.
Restore Factory Defaults	Reverts to the default values.
System Information	Displays the system information.
Reboot	Restarts the system.
PLC Monitor	Displays the PLC status when a PLC is connected.

### ● Network Address Setting Procedure

To connect the Web Server Unit to Ethernet, the IP address (the network address), subnet mask and default gateway need to be set. To set the Web Server Unit's network address, open the above-mentioned System Setting Screen, then select [Network] on the left menu to display the screen below. You can use either of the following methods to make the network settings.

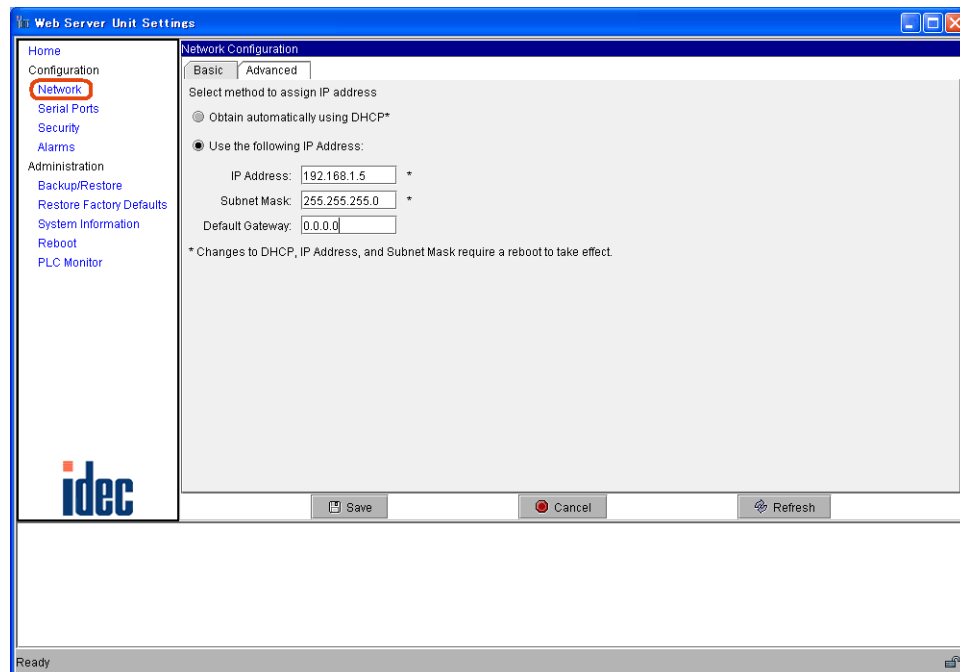

Network settings screen

1) Acquiring network address from DHCP server\*

This method acquires the Web Server Unit's network address from the DHCP server. In the network settings screen, select [Obtain automatically using DHCP], and click the [Save] button. The setting is applied when you connect to the network and then restart the Web Server Unit.

2) Fixed network address allocation

Sets a fixed user-specified network address. Make sure that every IP address set in the same network is unique. In the network settings screen, select [Use the following IP Address :], and enter the desired IP address, subnet mask and default gateway address. Click the [Save] button. The setting is applied when you connect to the network and then restart the Web Server Unit.

\* If there is no DHCP server in the same network used by the Web Server Unit, the network address can't be acquired, so use method (2) to set the network address.

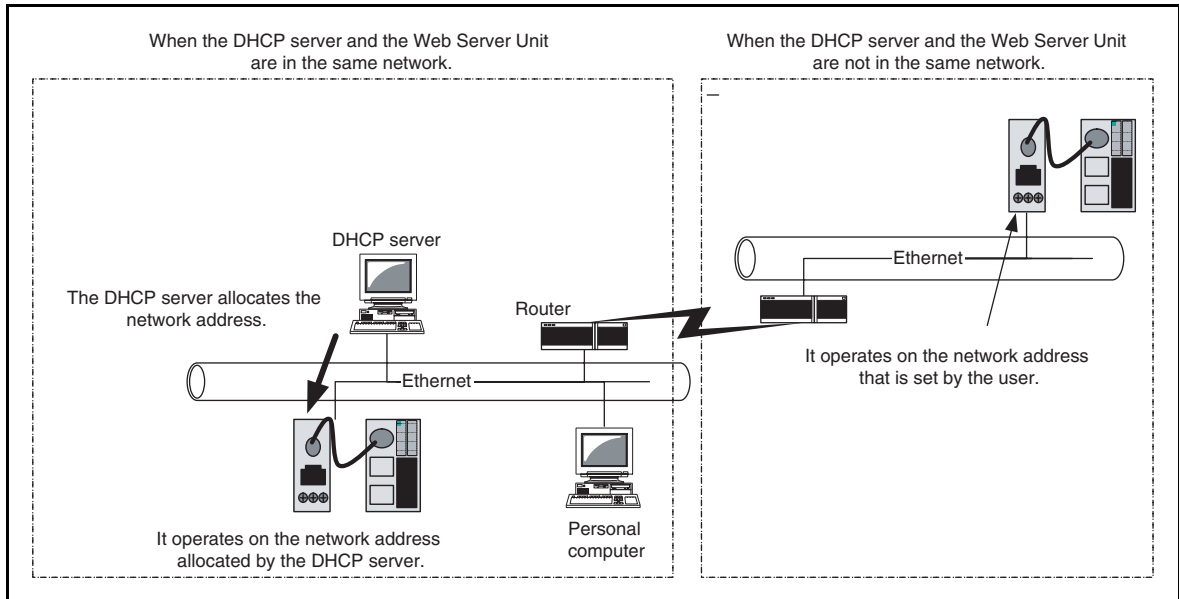

When using DHCP server or not

## ● Serial Communication Setting Procedure

The Web Server Unit and PLC are connected by serial communication. Settings such as the baud rate, data length, stop bit, parity bit and flow control are needed. To set Web Server Unit serial communication, open the System Setting Screen, and select [Serial Ports] on the left menu to display the screen below.

The MicroSmart serial communication defaults are shown below. Normally, there is no need to change the initial values of these items.

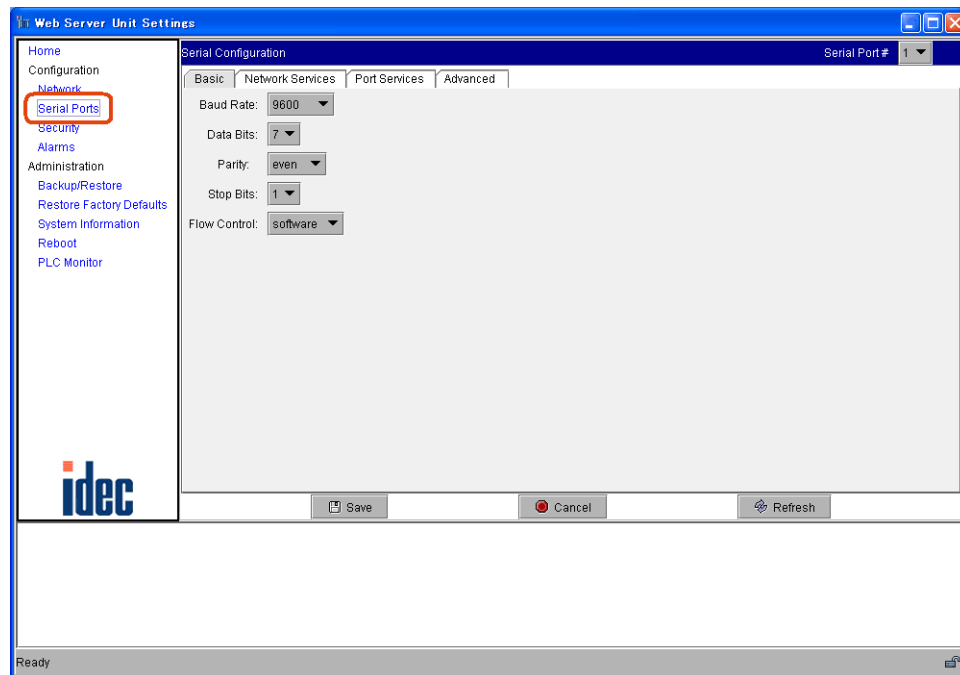

Serial port communication settings

Baud Rate: 9600 bps  
Data Bits: 7 bits  
Parity: Even  
Stop Bits: Bit 1  
Flow Control: None

## ● Other Function Settings

The other Web Server Unit settings are described below.

### 1) Security

Sets the user name and password. The setting is enabled to open the system screen or to use WindLDR for communication. The settings are applied after being saved.

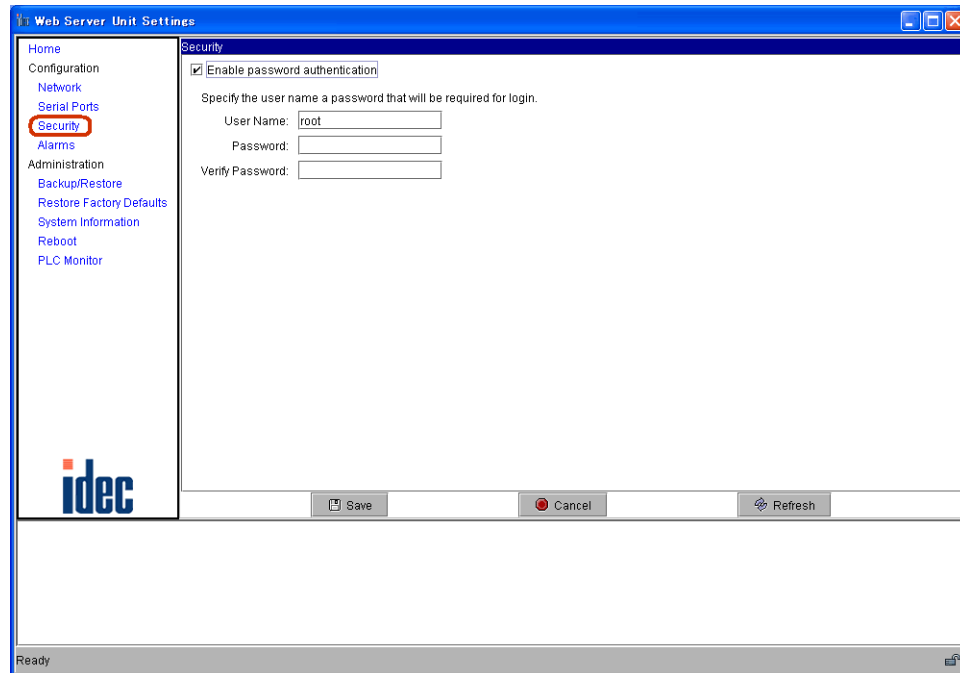

Password setting

Checking the [Enable password authentication] check box allows you to input the user name and password.

### 2) Mail Sending

Used to send messages from external devices as specified by the startup conditions. See Section 3-5, "Mail Sending Function".

### 3) Administration

- |                           |                                                                                      |
|---------------------------|--------------------------------------------------------------------------------------|
| Backup/Restore:           | Used to save or restore the current Web Server Unit settings.                        |
| Restore Factory Defaults: | Restores the Web Server Unit to the settings it had at the time of factory shipment. |
| System Information:       | Displays the Web Server Unit's system information.                                   |
| Reboot:                   | Restarts the Web Server Unit.                                                        |
| PLC Monitor:              | Displays the connected PLC's status information.                                     |

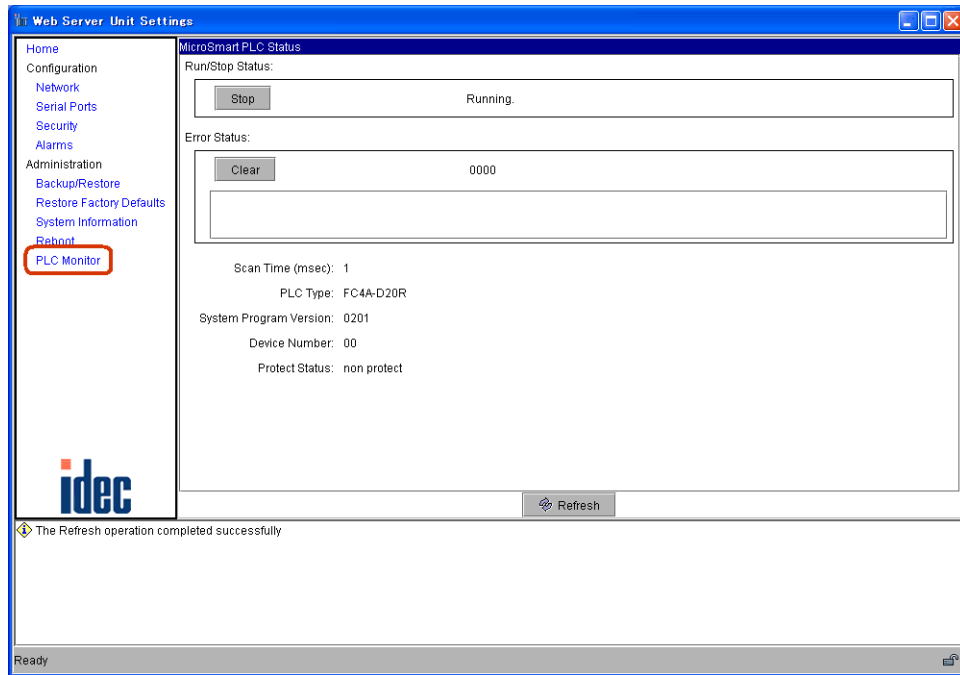

PLC monitor

## Remote Maintenance Function

This section describes the Web Server Unit's remote maintenance function. Use this function to perform remote PLC maintenance from WindLDR via the Web Server Unit.

### ■ System Configuration Example

Use Ethernet to connect the Web Server Unit to a PC with WindLDR version 4.70 (or a later version) installed. Make the network settings beforehand to enable a LAN or cross-cable connection.

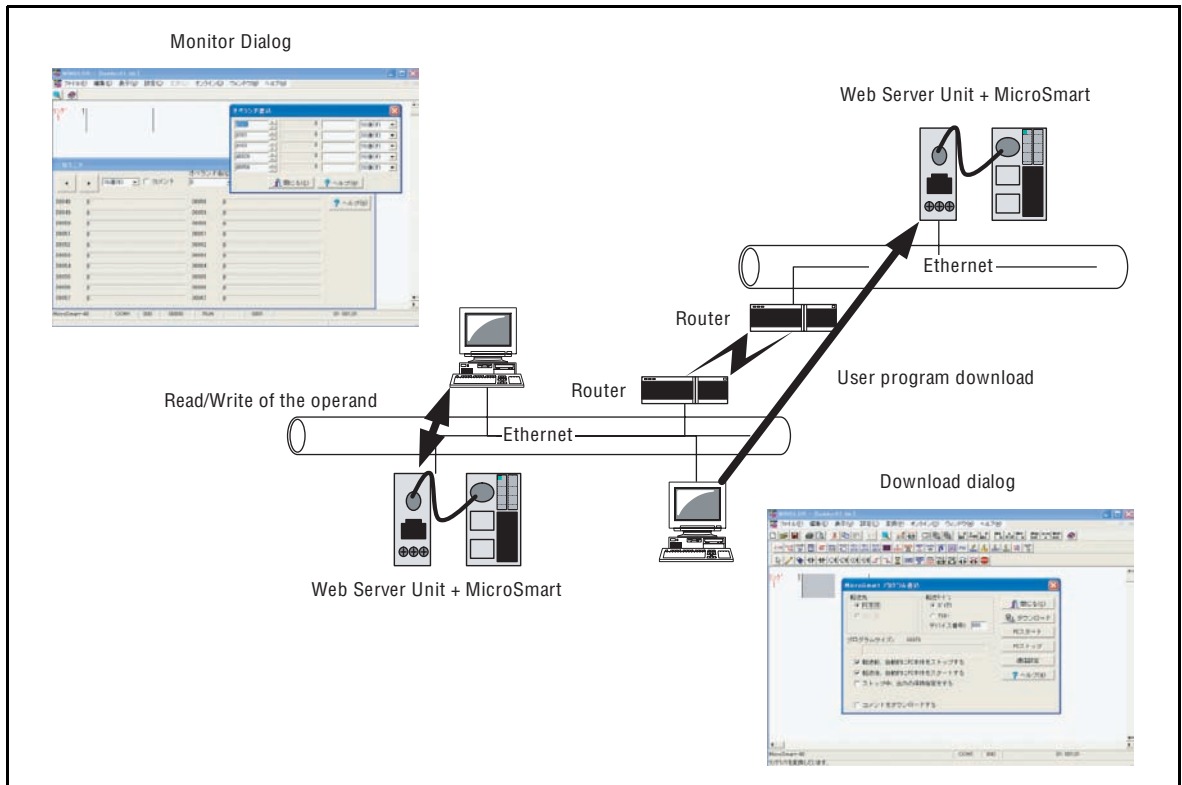
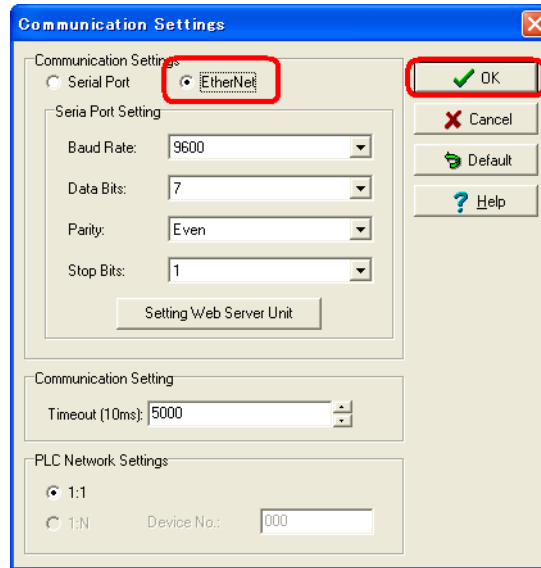

Illustration of LAN connection

## ■ WindLDR Settings

### ● Communication Setting Dialog

Select [Configure]→[Communication Settings]→[Ethernet], and press [OK]. A dialog for selecting the Web Server Unit is displayed the next time you start communication. Set the communication target to start.



Communication setting (Selecting Ethernet)

The screen below appears when communication starts. By pressing the [Search] button, the list of the Web Server Unit information appears in the WindLDR screen. Or otherwise, using the [Add] button enter the IP address and add the item for the list. Then select the communication target from the list and press [OK].

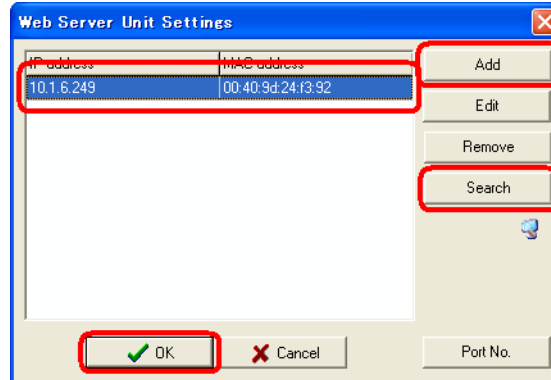

Communication setting (Selecting the target IP address)

## ■ Web Server Unit Settings

To perform remote maintenance, the Web Server Unit's network settings must enable connection, as shown below.

### ● Network Services Settings

TCP/IP port 2101 ON (default). You can access [Network Services] from [Configuration] → [Serial Ports] → [Network Services].

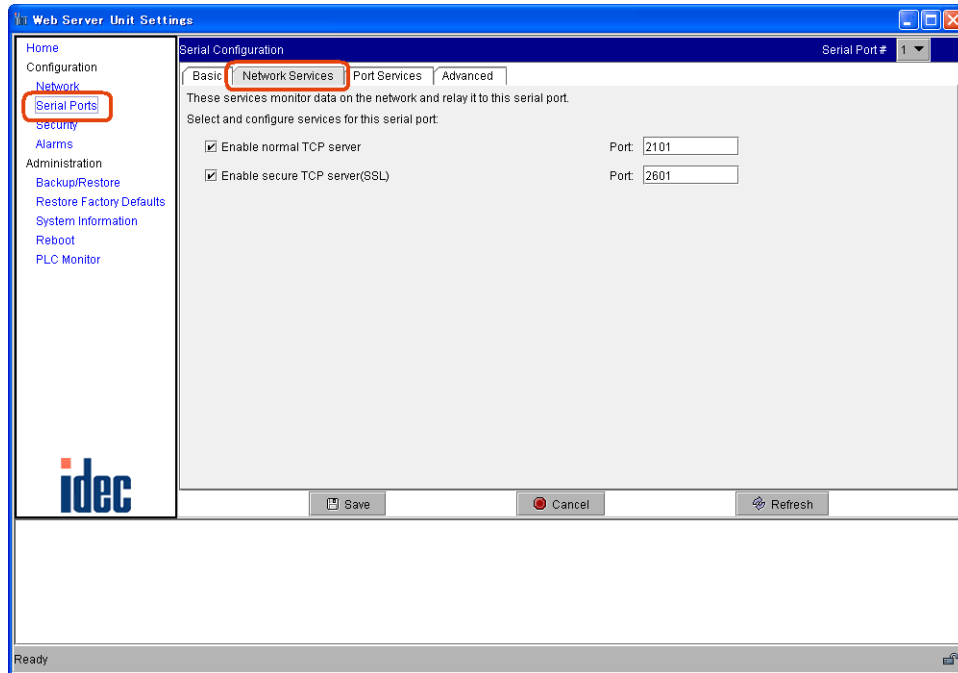

TCP/IP settings

### ● Serial Settings

Leave at the default settings. You can access from [Configuration] → [Serial Ports] → [Basic].

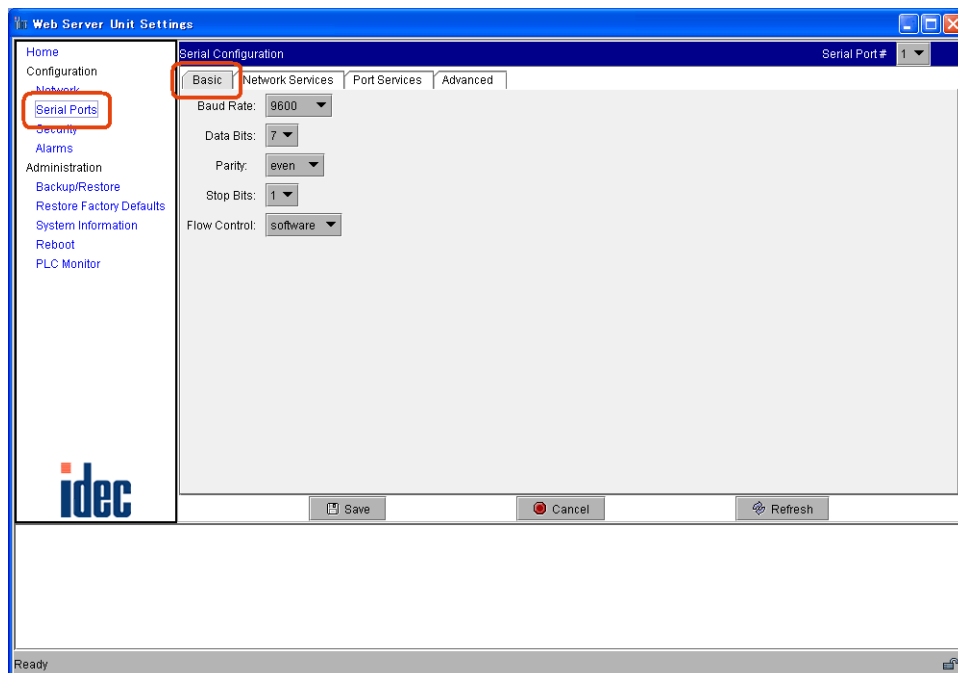

Serial settings

## ■ Remote Maintenance From WindLDR

You can perform PLC remote maintenance from WindLDR via the Web Server Unit. Among the online functions supported by the serial port, the functions below can be used on the network.

- Online Monitor
- Communication Error
- Upload Program
- Verify Program
- Download Program
- Partial Program Download



### NOTE

In some communication environments, it takes time to transfer the data. Set the timeout value in the WindLDR communication settings and PLC communication settings as needed.

If the communication time-out occurs at time of download by way of Web Server Unit, set the time-out value - [Configure]→[Communication Settings]→[Timeout] - longer than the current value. For reference, if the program size is 32 KB, the time-out value is greater than or equal to 2,400×10m sec, though this value is somewhat different depending on the network situations.

When user name/password authentication is set in the Web Server Unit, you will be prompted for authentication during WindLDR communication access. Enter the user name and password. Communication starts when authentication has been performed.

## ■ SCADA Software/OPC Server

Using the Web Server Unit with an OPC server or SCADA that supports Ethernet enables Ethernet-based MicroSmart data reading/writing. This feature enables graphical operation monitoring, and servicing/maintenance with an outstanding GUI.

### Confirmed software

WindSRV, IDEC Corporation

For more detail, please contact IDEC.

## Web Server Function

The Web Server Unit's Web server function enables operations such as PLC monitoring using a Web browser with Java applets.

### ■ PLC Operand Monitor

A PLC operand monitor is provided as a sample program. The PLC operand monitor is not installed in the Web Server Unit with the initial settings at time of factory shipment. You must upload the sample PLC operand monitor from the CD-ROM provided.

#### ● System Configuration Example

First make the network settings, then connect the Web server to a PC with a Web browser using a LAN or cross cable. When monitoring, MicroSmart should be connected to the Web Server Unit and activated.

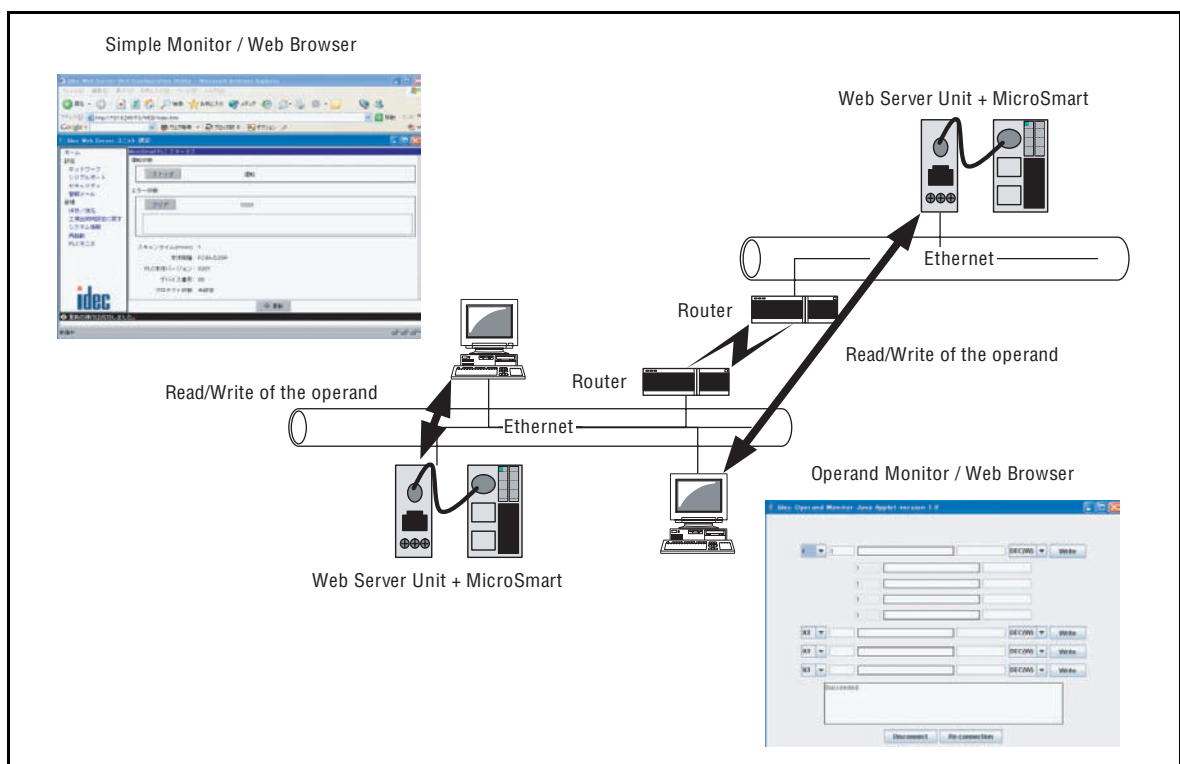

Illustration of LAN connection

The PC must be able to run a Web browser (such as Internet Explorer), and JavaScript and Java applets must be enabled.

#### ● Web Browsers

Confirmed Web browsers:

Internet Explorer 6.0, Netscape 7.1

\* The Java VM running environment is required.

#### ● Uploading PLC Monitor Sample Screen

How to upload the PLC monitor screen is described below. At time of factory shipment, the PLC monitor screen is not installed in the Web Server Unit. (Use the Java Applet Monitor from the CD-ROM.)

Due to restrictions on server file volume capacity, the System Setting Screen and Java applet monitor can't coexist.

How to upload the sample program (Java applet) is described below, using Internet Explorer 6.0 as an example.

1. Start Internet Explorer.

- In the address bar, enter the Web Server Unit's IP address and the file name, as shown below (example: when the IP address is 192.168.1.101). The settings screen for management appears.  
<http://192.168.1.101/home.htm>  
 The screen below appears.

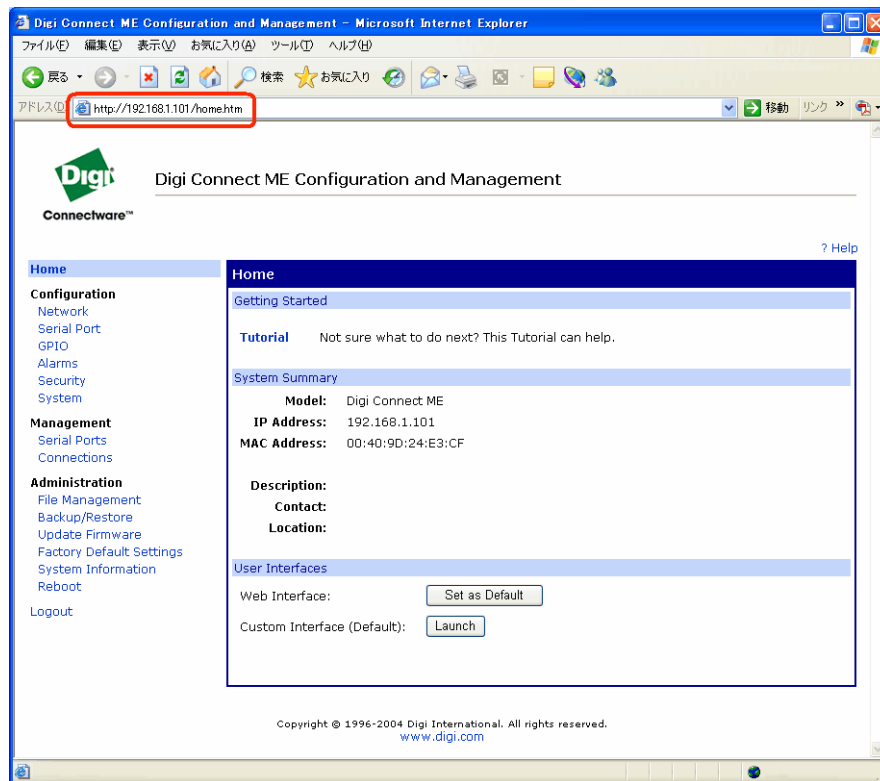

Settings screen for management

- Open the [File Management] screen and delete the files currently in the server. Select [File Management] from the menu on the left. The screen below appears.

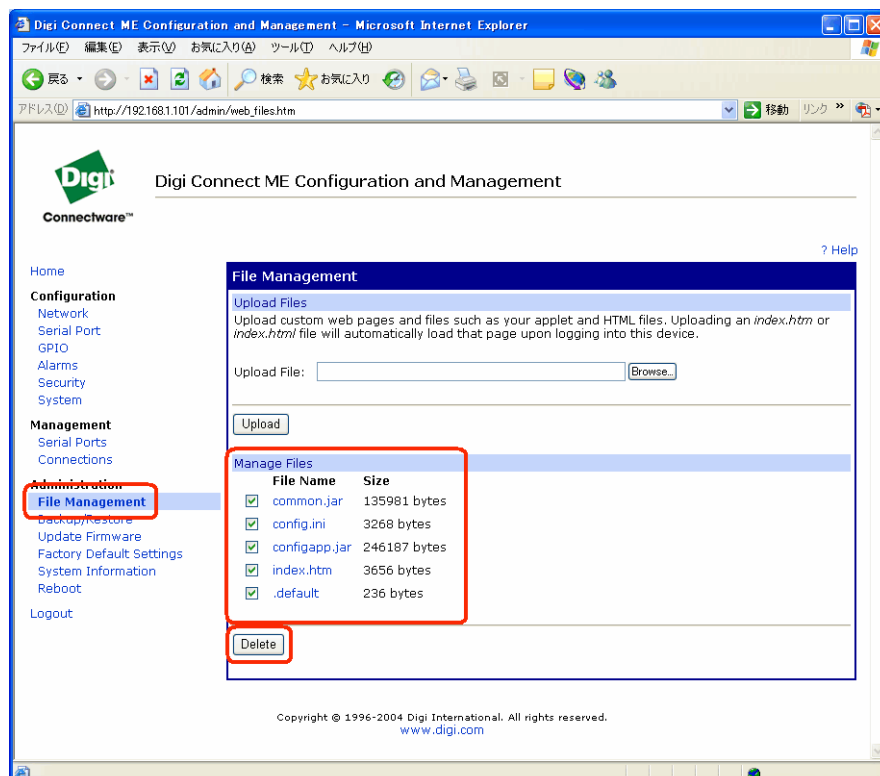

File Management screen

4. Check all files under [Manage Files], and click [Delete]. The files are deleted and the screen below appears.

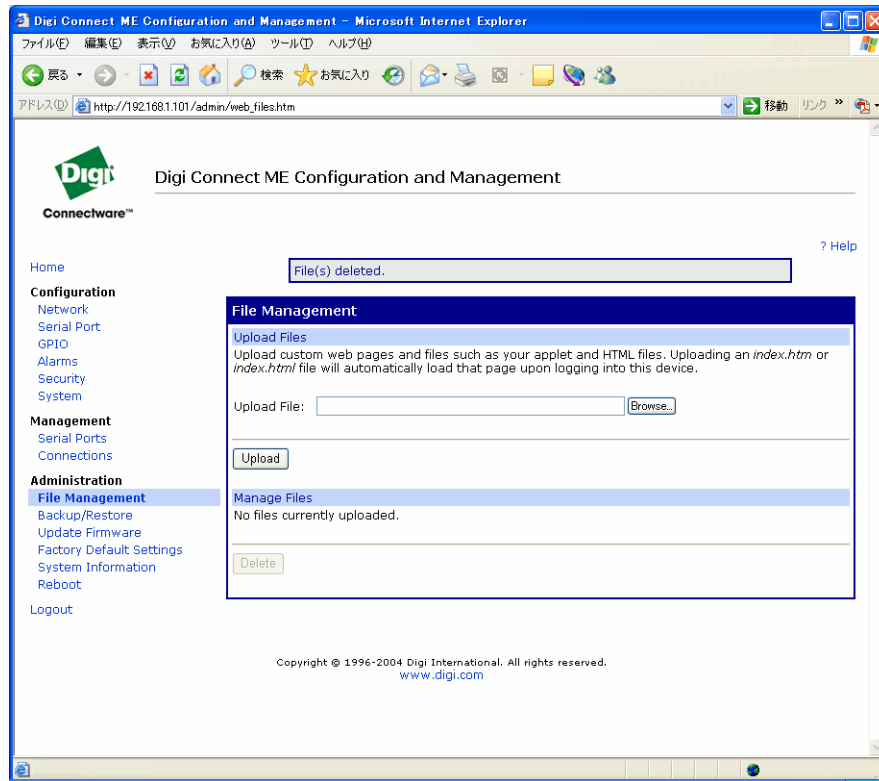

Screen after the files are deleted

5. You are now ready to upload the files. Upload the two files below. The sample program consists of the applet that generates the monitor screen and the HTML file that runs the applet.

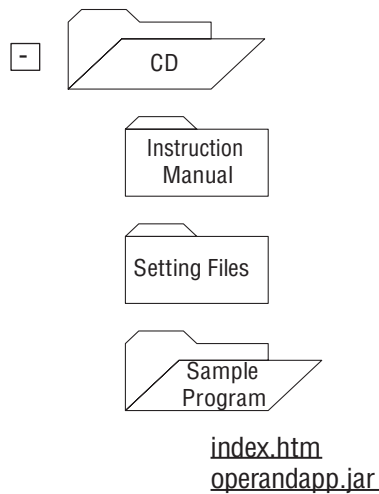

6. Click the [Browse...] button, and select the desired file by clicking on it. Click the [Upload] button. Repeat this process to upload the two files. When uploading has finished, the screen below appears.

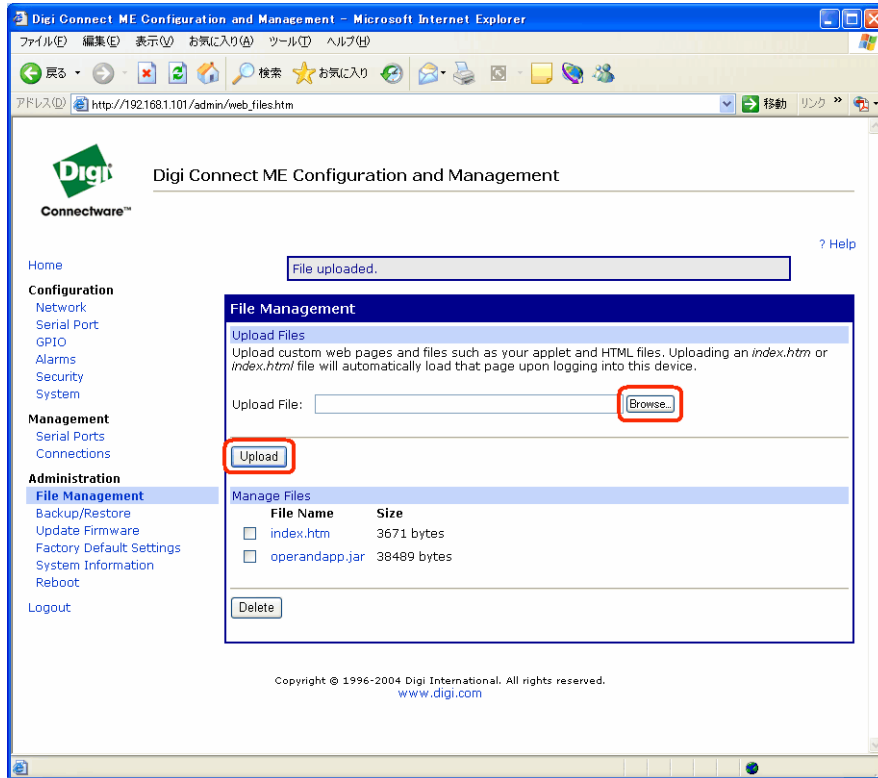

Screen after uploading the file is completed

7. Click [Home] on the left menu. To make the screen the initial screen, click [Set as Default] in the screen below. The next time you open the Web browser, the default screen displayed when this server is accessed will be the PLC operand monitor. (Restart the Internet Explorer.)

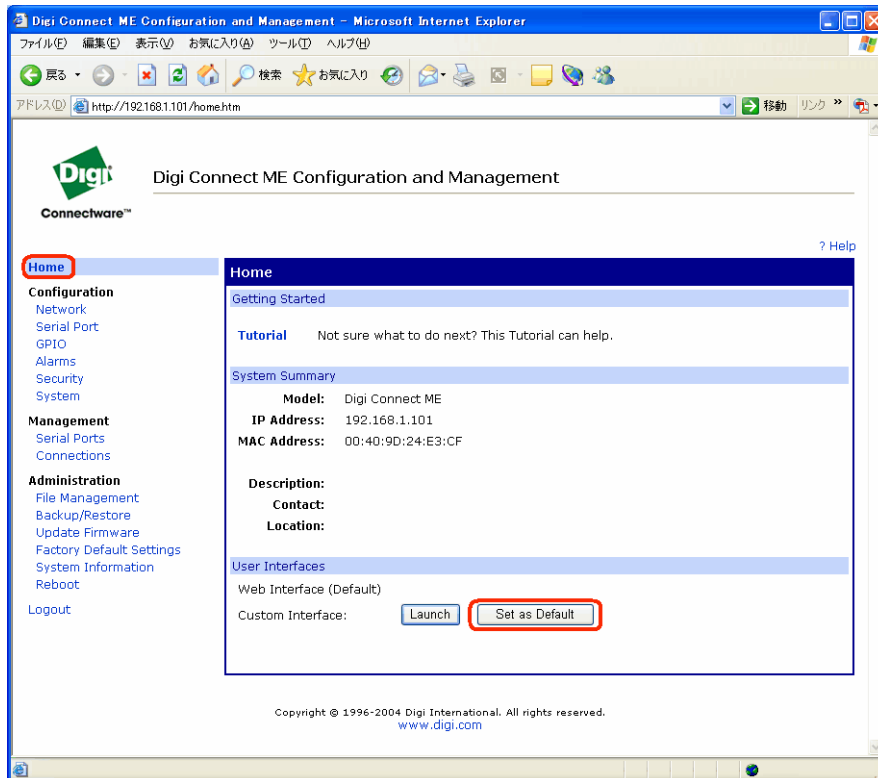

Set as Default screen

- To restore the original system setting screen, repeat Steps 1 to 4 to delete all the files, then upload all the files below by the method of Step 6. Next, click 'Set as Default' as in Step 7 to make the system setting screen the default screen.

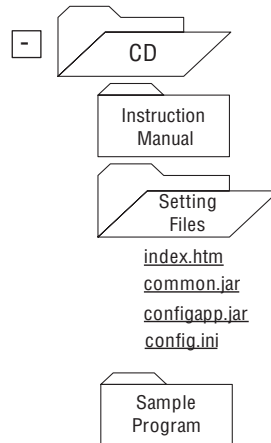

### ● PLC Operand Monitor

An operation example using the sample program (Java applet) is given below. This example is for Internet Explorer 6.0.

- Enter the Web Server Unit's IP address in the address bar as shown below (example: when the IP address is 192.168.1.101).  
`http://192.168.1.101/`
- The initial screen starts the sample program (PLC operand monitor). Program downloading starts, and a warning dialog appears asking whether to start the applet. Select [Yes] or [Always]. If you select [Always], this dialog will not appear the next time the sample program starts.

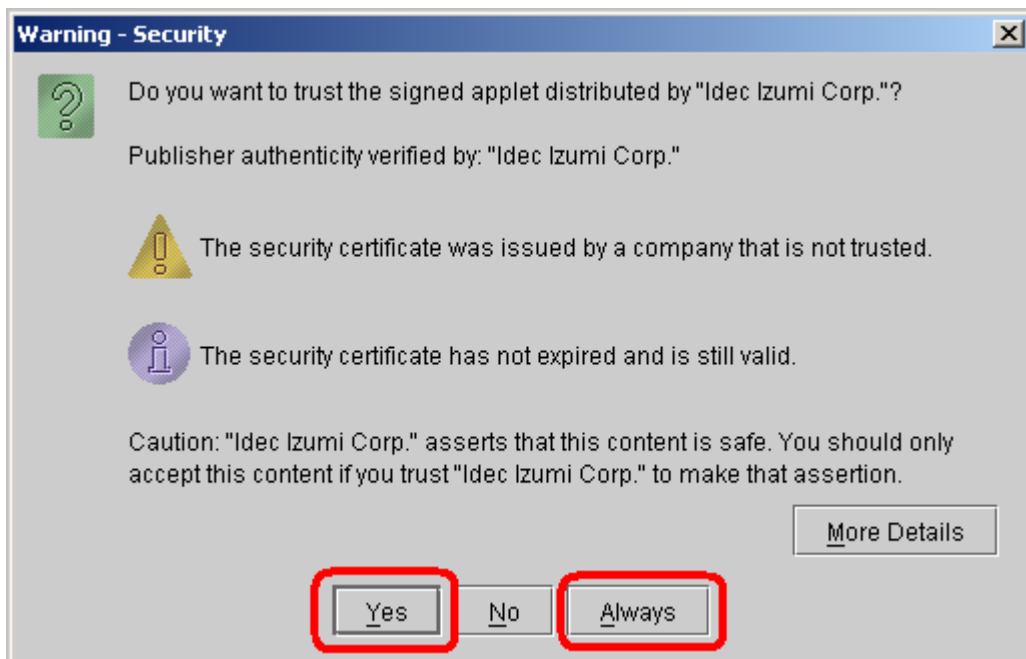

Warning dialog

- IDEC operand monitor starts. If you have set the user name and password in the Web Server Unit in advance, you are prompted to enter them.

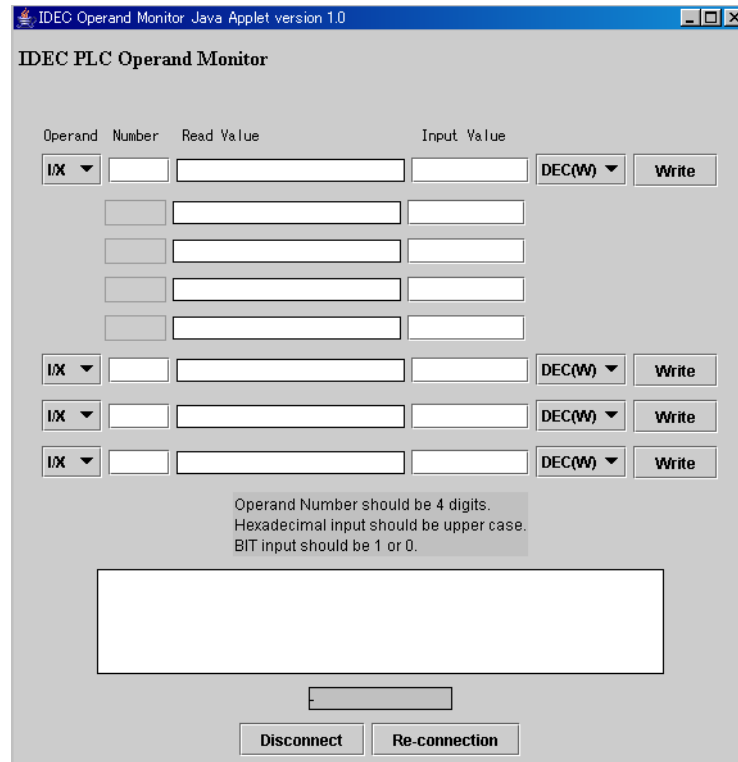

Operand Monitor Java Applet

- You can now perform operand monitoring and writing. Select the operand type and enter the address. Addresses are 4 digits. Five consecutive addresses can be written or monitored at the top part. Enter the values in the input field and press the [Write] button to write the values.

### Operand types

I/X	Input (word)	i/x	Input (bit)
Q/Y	Output (word)	q/y	Output (bit)
M	Internal relay (word)	m	Internal relay (bit)
R	Shift register (word)	r	Shift register (bit)
T	Timer (set value)		
t	Timer (count value)		
C	Counter (set value)		
c	Counter (count value)		
D	Data register		

### Display formats

DEC(W)	Decimal (unsigned)	DEC(I)	Decimal (signed)
DEC(D)	Decimal (unsigned), 2 words	DEC(L)	Decimal (signed), 2 words
HEX(W)	Hexadecimal	HEX(D)	Hexadecimal, 2 words
BIT	Bit		



#### NOTE

- The PLC operand monitor screen is stored in the Web Server Unit, but executed by the PC.
- The Java applet performs communication between the PC it runs on and the Web Server Unit.
- The Web Server Unit relays commands received on Ethernet (TCP/IP) to the PLC, and returns the PLC's reply on Ethernet (TCP/IP).

## ■ User Screen Creation

The original PLC monitor screens can be made and built into the Web Server Unit. Also the sample page can be referred to this programming. To make these screens, the knowledge for Java Applet is required. For more information, see the Sun Microsystems Inc. web site.

### ● Sample Program Creation Environment

The sample program PLC operand monitor was created on Java 2 SDK Standard Edition version 1.4.2, and Ant 1.6.

### ● Creating/Uploading

The sample program source code is included in the CD-ROM provided. The CD-ROM also includes referential materials such as the Java.doc file.

To upload a created HTML file or Java applet, see the previous section of “Uploading PLC Monitor Sample Screen”.

#### CAUTION



- Sample programs are provided as is, and their operation is not always guaranteed.
- Security precautions and other adaptations should be made when running them on the network.

## Ethernet User Communication Function

This section describes Ethernet user communication for the Web Server Unit. MicroSmart user communication can support Ethernet via the Web Server Unit.

### ■ System Configuration Example

Ethernet user communication enables the Web Server Unit to communicate between MicroSmart modules or communicate with another device (with an IP address set).

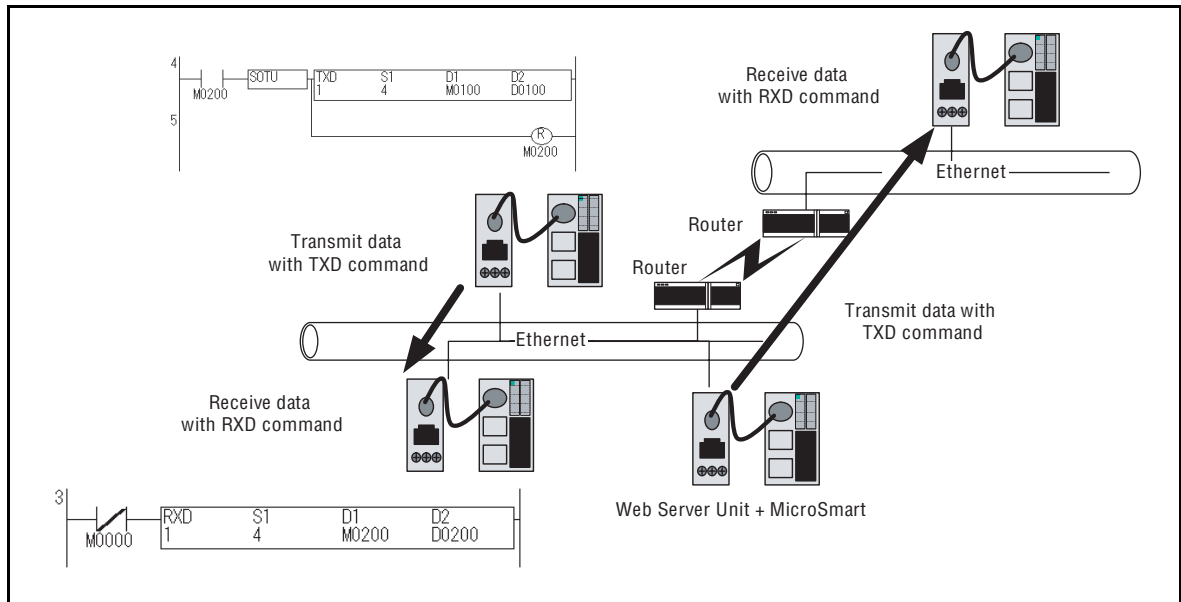

Example of a system configuration for Ethernet user communication



### NOTE Conditions for Ethernet user communication

- 1) Remote communication device  
The Ethernet user communication feature enables user communication using the TCP protocol client function. A device with a TCP protocol server function must be selected as the remote communication device.
- 2) Number of remote communication devices  
Ethernet user communication can only be performed with the registered IP address port No. In other words, there can only be one remote communication device.

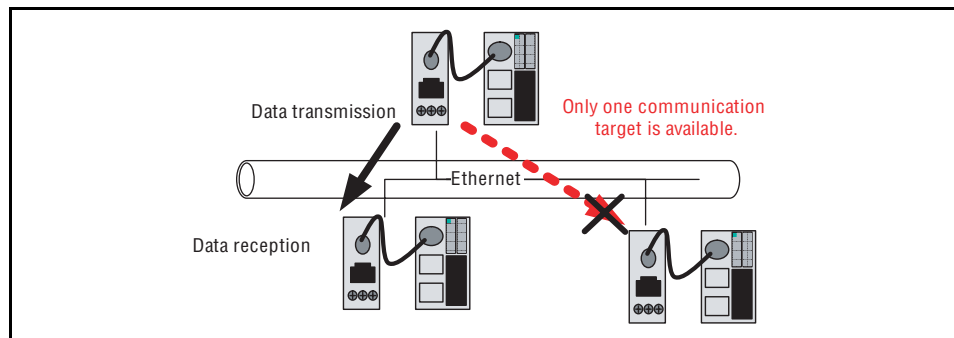

Conditions for Ethernet user communication

## ■ Web Server Unit Settings

Follow the procedure below to make the Web Server Unit settings.

### ● Switching Web Server Unit Mode

Turn the Web Server Unit's mode selection switch to "USER".

\* The default setting of the Web Server Unit's mode selection switch is "REMOTE".

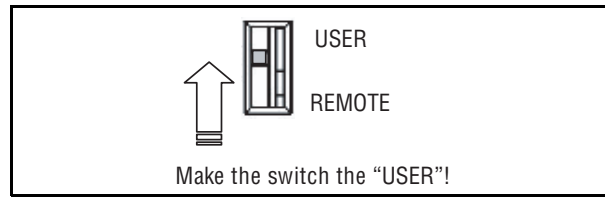

Function selector switch



#### NOTE

Performing Ethernet user communication between MicroSmart modules

To perform Ethernet user communication between MicroSmart modules, the only operation needed for the Web Server Unit on the TCP protocol server is to set the mode selection switch to "USER".

The rest of the setting procedure is given in the description of the TCP protocol client settings.

### ● Opening Web Server Unit System Setting Screen

Open the Web Server Unit's settings screen.

There are two ways to open this screen:

- 1) Opening settings screen from WindLDR (see "System Setting Screen" in Section 1 of Chapter 3 for more information)
  1. Select [Setting Web Server Unit] in WindLDR.
  2. The previously set IP address appears in the WindLDR screen.
  3. Double-click the IP address of the Web Server Unit performing Ethernet user communication. The Web browser starts, and the System Setting Screen as below appears.
- 2) Opening settings screen directly from Web browser
  1. Start the Web browser.
  2. In the Web browser's address bar, enter the IP address of the Web Server Unit performing Ethernet user communication, and press the Web browser's [Refresh] button or the keyboard's Enter key.
  3. The System Setting Screen appears.

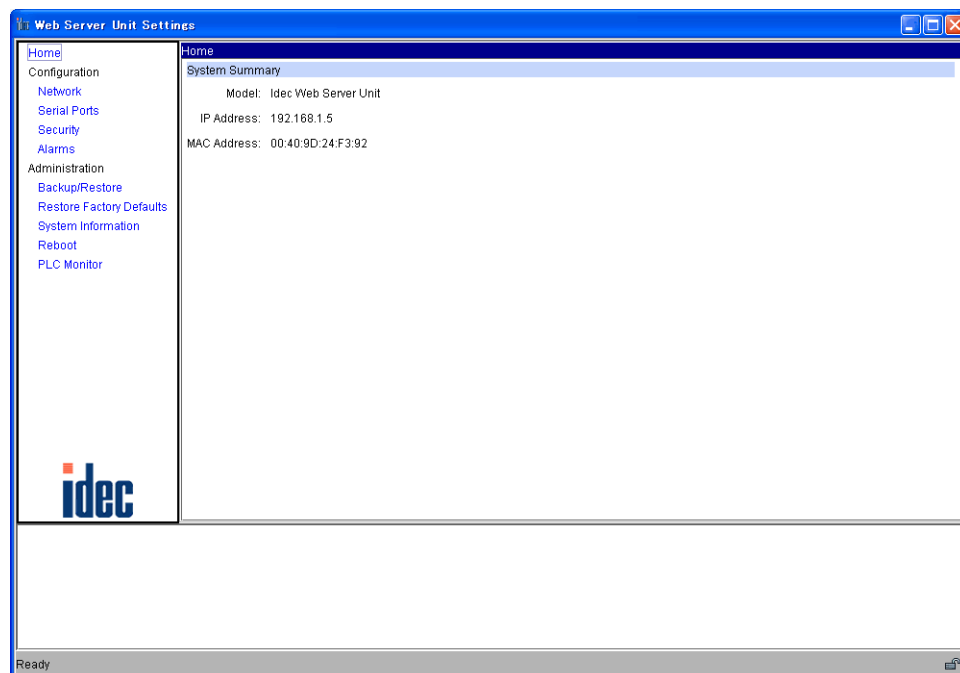

System Setting Screen

## ● Setting TCP Client Mode

1. Specify [Serial Ports] in the left menu of the system setting screen, and select the [Port Services] tab.

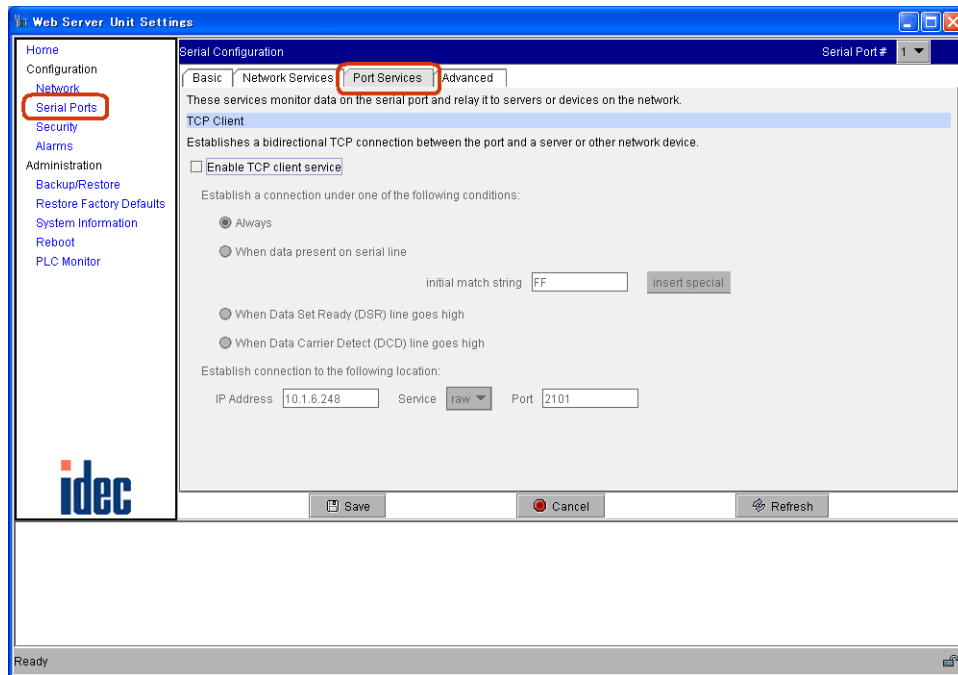

Port Services

2. Check the [TCP Client]- [Enable TCP client service] check box.

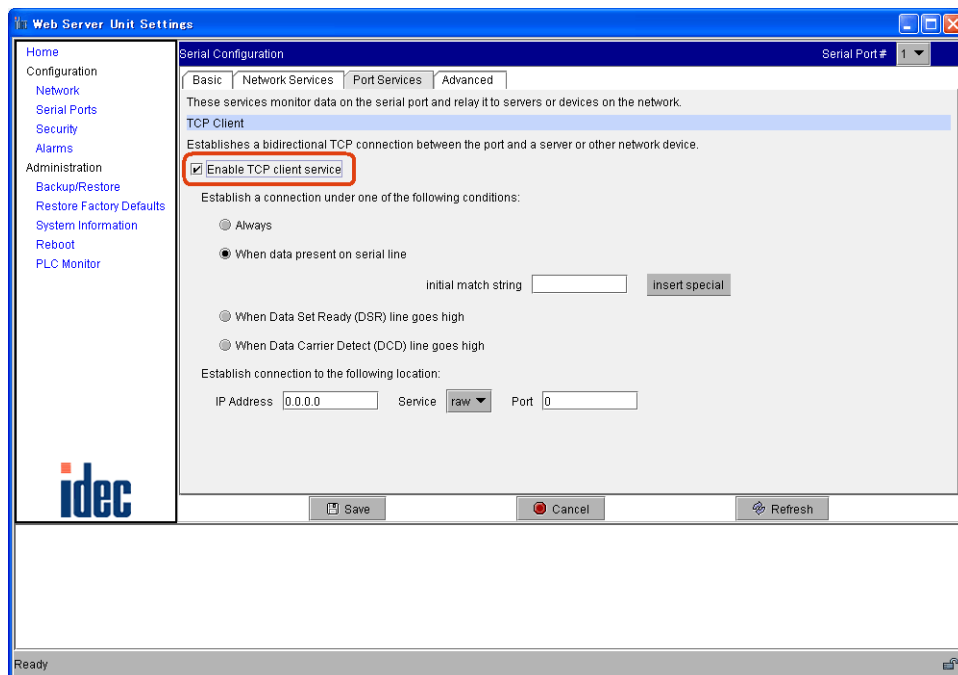

Enable TCP client service

3. Select [Always] or [When data present on serial line].

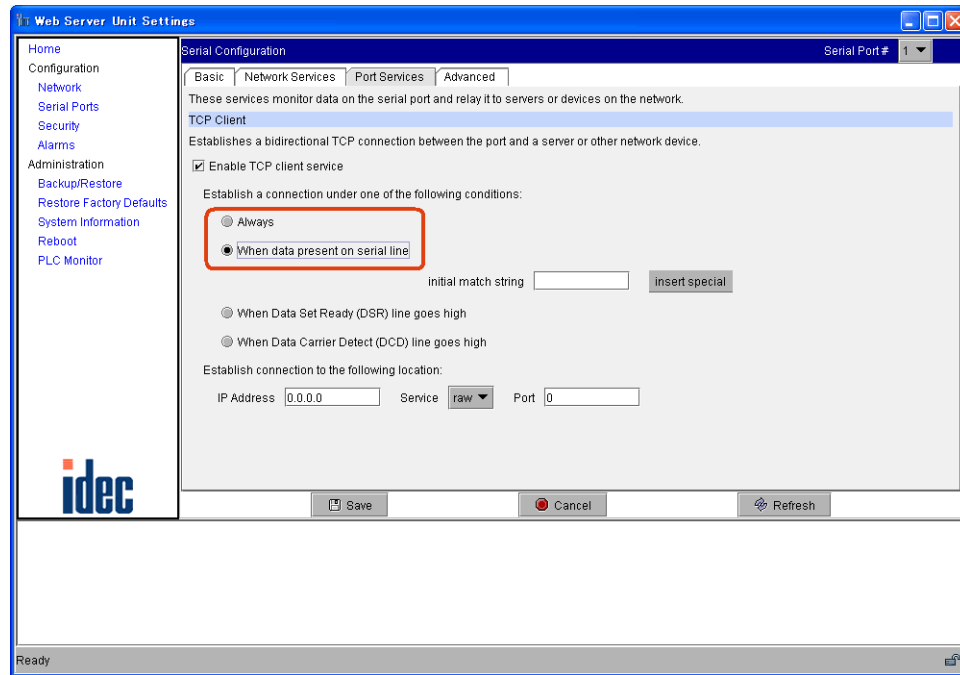

TCP client connecting conditions



**NOTE**

Difference between [Always] and [When data present on serial line]  
 [Always] and [When data present on serial line] each specify a different timing for sending the request to establish the communication path to the remote communication device.

Item	Timing for sending request to establish communication path
Always	When power is turned ON
When data present on serial line	When registered data is received from serial line

4. When selecting [When data present on serial line], enter the character string used for starting Ethernet user communication in the [initial match string] field.

You can enter up to 31 characters (only single-byte alphanumeric characters).

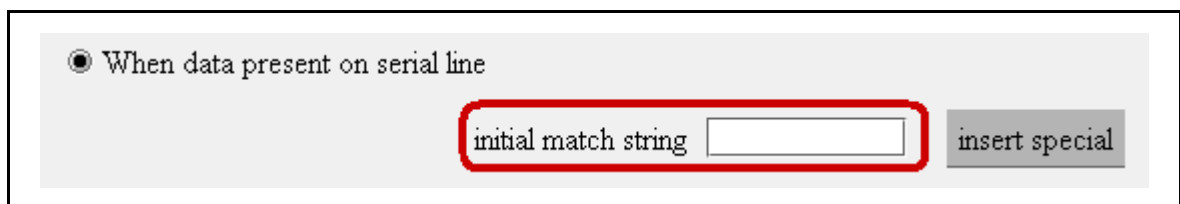

Enlarged character string input screen



**NOTE**

When [When data present on serial line] is selected  
 The registered character string used to start Ethernet user communication is the trigger for sending a communication path establishment request to the remote communication device. It is also data sent to the remote communication device. In other words, the registered character string is sent to the remote communication device. If this registered character string is not needed by the remote communication device, it must be deleted by the remote communication device's settings or receiving program.

5. Click the [Save] button, and the [Reboot] button on the left menu to complete the setting procedure.

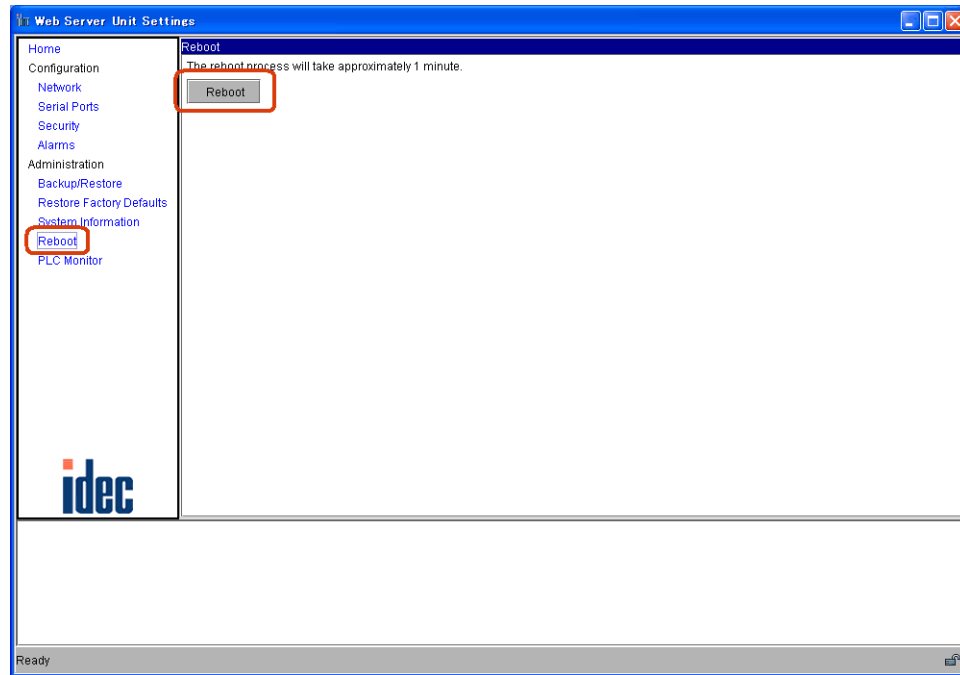

Reboot screen

## ■ MicroSmart Settings

MicroSmart user communication commands are used to perform Ethernet user communication.

### ● User Communication Command Settings



**NOTE**

For more information on user communication, see Chapter 17, “User Communication Instructions” in the MicroSmart instruction manual.

1. Set the MicroSmart port for performing Ethernet user communication (1st or 2nd port).  
In WindLDR, select [Configuration] → [Function Area Settings] → [Communication] tab.  
Select the port to use for Ethernet user communication under [User Protocol].

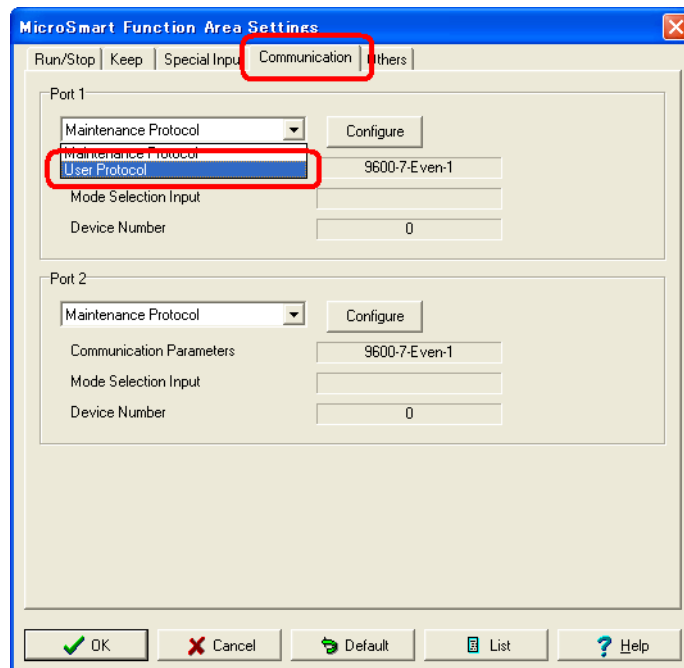

User protocol selection

2. Enter the user communication command in the ladder program.  
Enter the TXD command or RXD command in the ladder program.

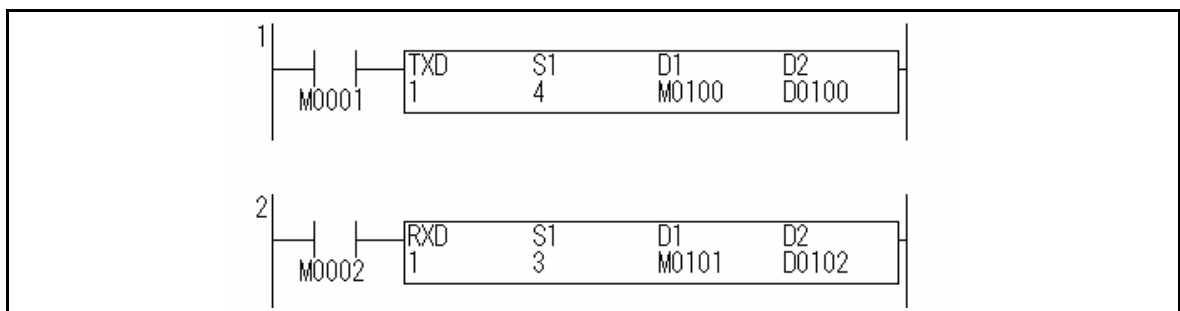

TXD and RXD commands in a ladder program

3. Download the ladder program.  
In WindLDR, select [Online] → [Download Program...] → [Download].



**NOTE**

When [When data present on serial line] is set in the Web Server Unit settings  
When [When data present on serial line] is set for the Web Server Unit's TCP client mode, be sure to make the character string registered in the Web Server Unit the same as the character string data used by the TXD command. Ethernet user communication is only possible when the strings are the same.

## ■ Ethernet User Communication Sample Program

### ● Communication Between MicroSmart Modules

System configuration

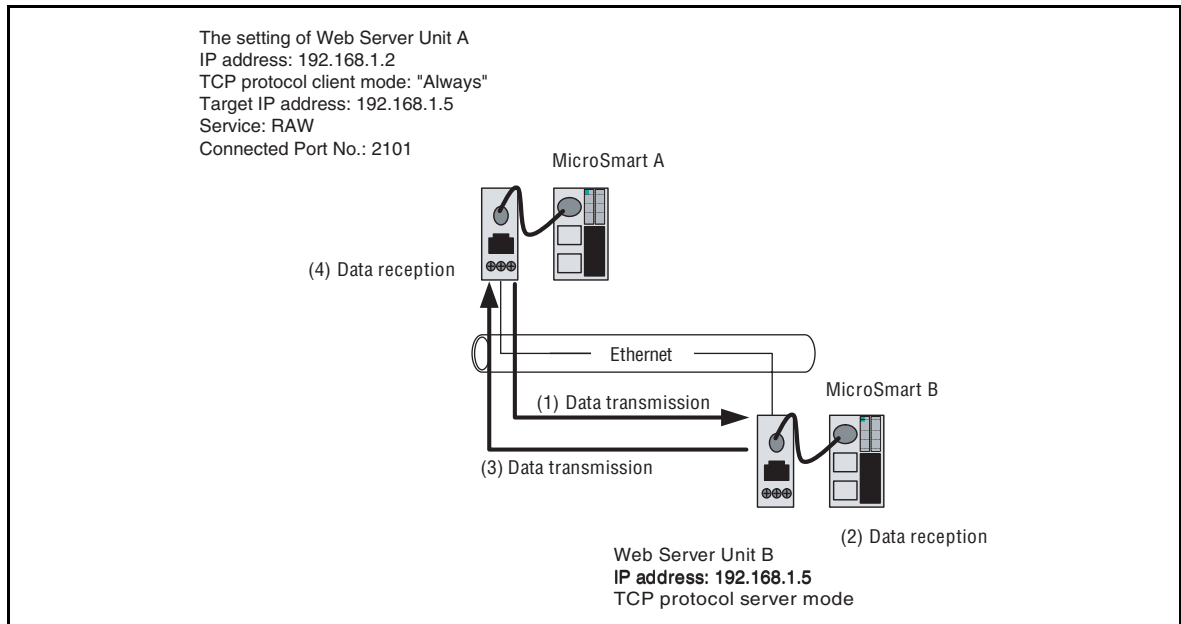

Communication between MicroSmart modules

Web Server Unit A: TCP protocol (Client mode)

Web Server Unit B: TCP protocol (Server mode)

MicroSmart A

MicroSmart B

- 1) MicroSmart A transmits data with the TXD command, and becomes ready to receive data with the RXD command. Web Server Unit A transmits the data sent from MicroSmart A to Web Server Unit B (to which the target IP address, the service and the target port number are registered).
- 2) Web Server Unit B receives the data addressed to it, and transmits data to MicroSmart B. MicroSmart B receives the data with the RXD command.
- 3) MicroSmart B transmits data with the TXD command. Web Server Unit B transmits the data sent from MicroSmart B to Web Server Unit A.
- 4) Web Server Unit A receives the data addressed to it and transmits data to MicroSmart A. MicroSmart A receives data with the RXD command.

● **Sample Ladder Program**

MicroSmart on Web Server Unit A side

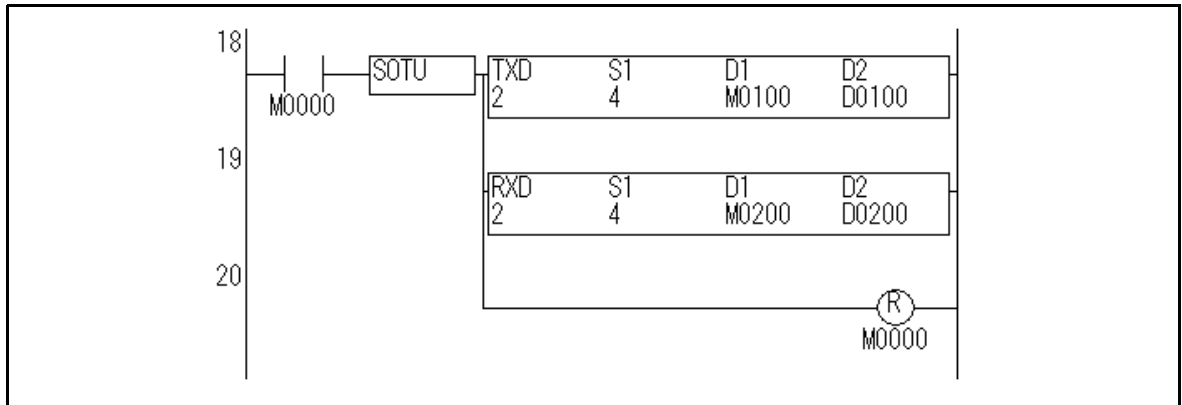

If the start input M0000 is turned on, MicroSmart transmits 4-byte data from port 2, and becomes ready to receive data.

MicroSmart on Web Server Unit B side

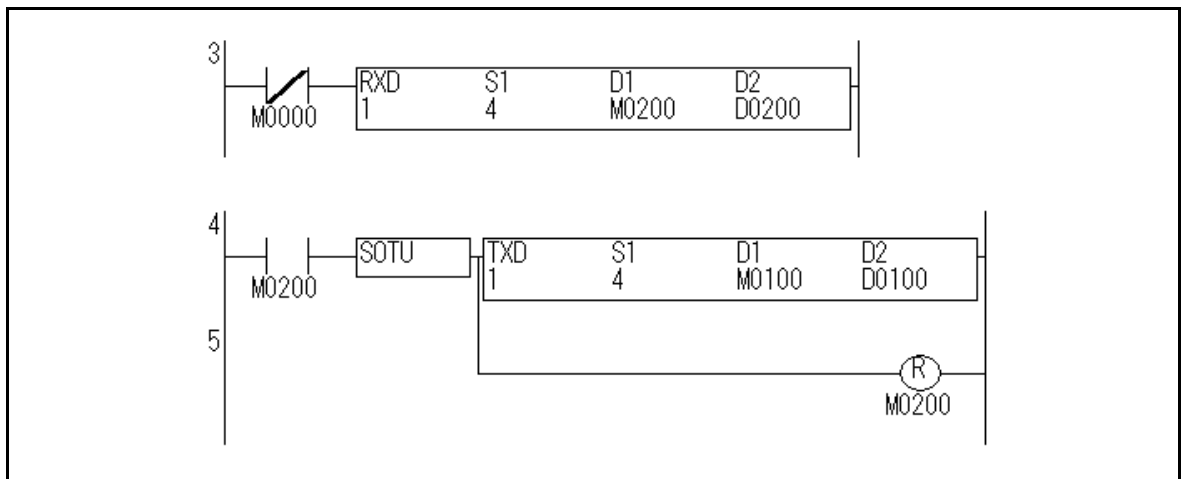

When it finishes receiving 4-byte data from port 1, and then transmits 4-byte data from port 1.

## Mail Sending Function

This section describes the Web Server Unit's mail sending function.

You can use MicroSmart's user communication functions to send messages to devices that can receive mail from PCs or similar devices.

### ■ System Configuration Example

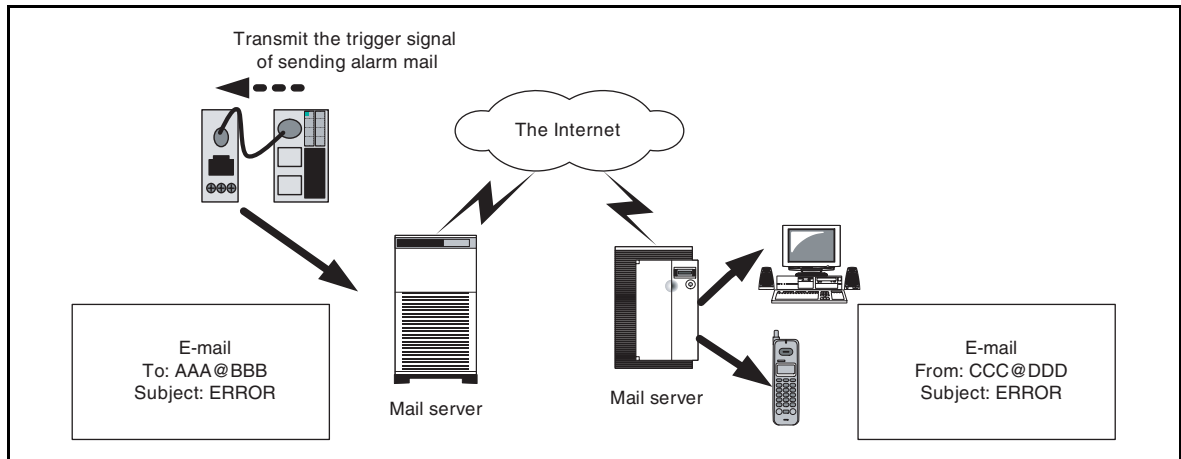

Configuration example of mail transmission system



**NOTE**

#### Conditions for using mail sending function

- 1) Mail server  
A mail server IP address is needed to send messages. Ask your network administrator for your mail server IP address.

## 2) Messages

- The character strings registered in the Web Server Unit (up to 63 single-byte alphanumeric characters) can be sent as messages utilizing the subject column of the E-mail.
- The message body is fixed to “Data Pattern Alarm”.
- You can specify up to 32 different messages (subjects), with 2 recipient mail addresses for each.
- You can set recipient mail addresses of up to 64 single-byte alphanumeric characters.
- Mail sending timing: Messages are sent only when the character string registered in the Web Server Unit is received from the serial line.

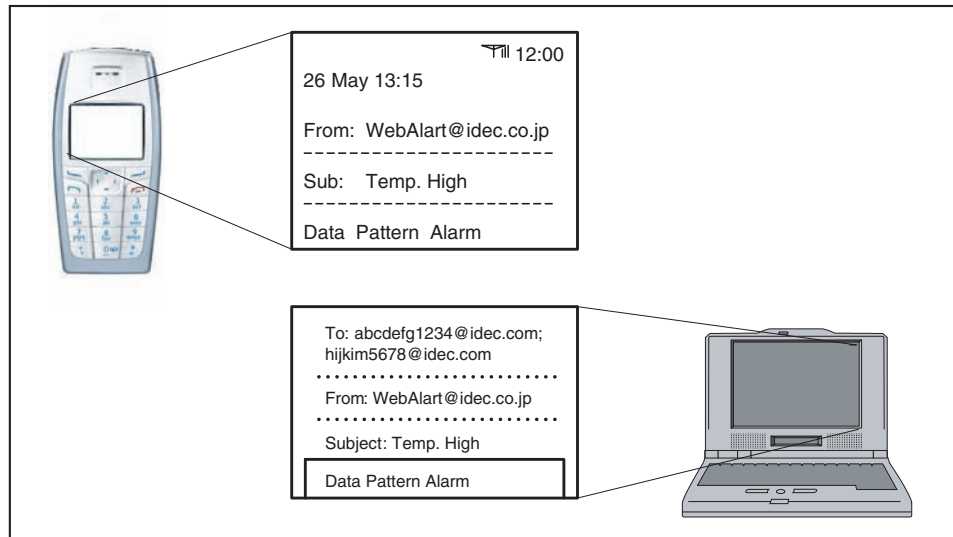

Illustration of mail transmission

## ■ Web Server Unit Settings

Follow the procedure below to make the Web Server Unit settings.

### ● Switching Web Server Unit Mode

Set the Web Server Unit's mode selection switch to “USER”.

\* The default setting of the Web Server Unit's mode selection switch is “REMOTE”.

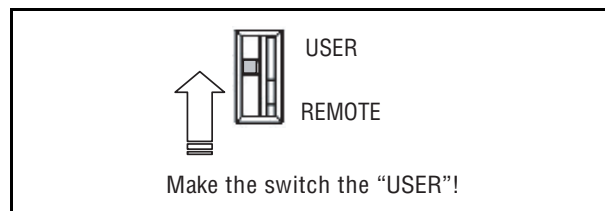

Function selector switch

### ● Opening Web Server Unit System Setting Screen

Open the Web Server Unit's setting screen.

There are two ways to open this screen:

- 1) Opening settings screen from WindLDR (see “System Setting Screen” in Section 1 of Chapter 3 for more information).
  1. Select [Setting Web Server Unit] in WindLDR.
  2. The previously set IP address appears in the WindLDR screen.
  3. Double-click the IP address of the Web Server Unit performing Ethernet user communication. The Web browser starts, and the System Setting Screen as below appears.
- 2) Opening settings screen directly from Web browser
  1. Start the Web browser.
  2. In the Web browser's address bar, enter the IP address of the Web Server Unit performing Ethernet user communication, and press the Web browser's refresh button or the keyboard's Enter key.

3. The System Setting Screen appears.

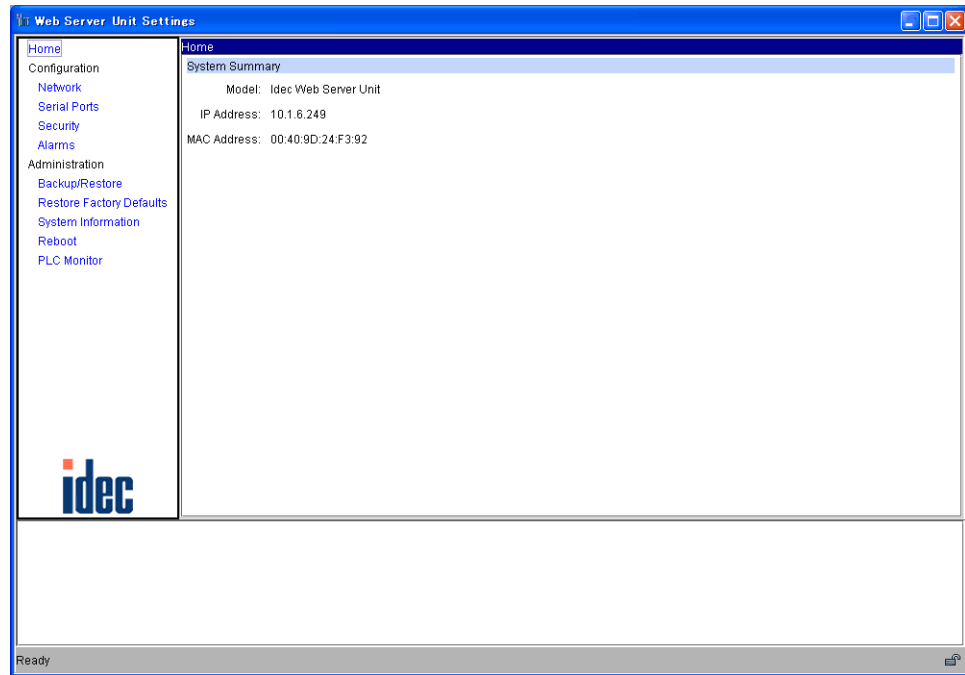

System Setting Screen

## ● Alarms

1. Specify [Alarms] on the left menu of the system setting screen, and check the [Enable sending alarms] check box.

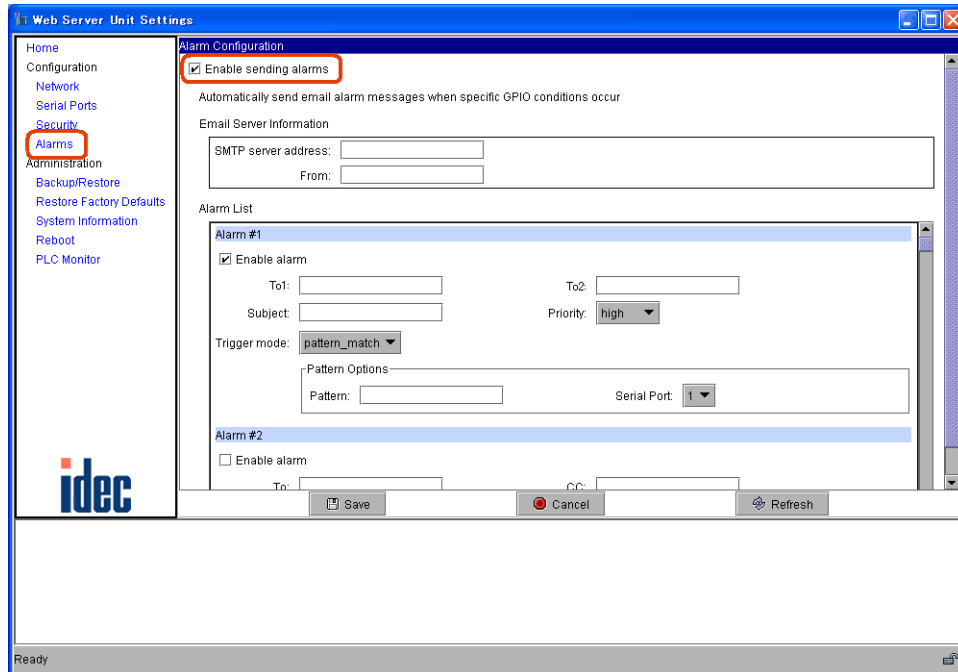

Alarms

2. Enter the mail server's IP address in the [SMTP server address] field, and the Web Server Unit's mail address\* in the [From] field.  
\* Ask your network administrator for the mail address.

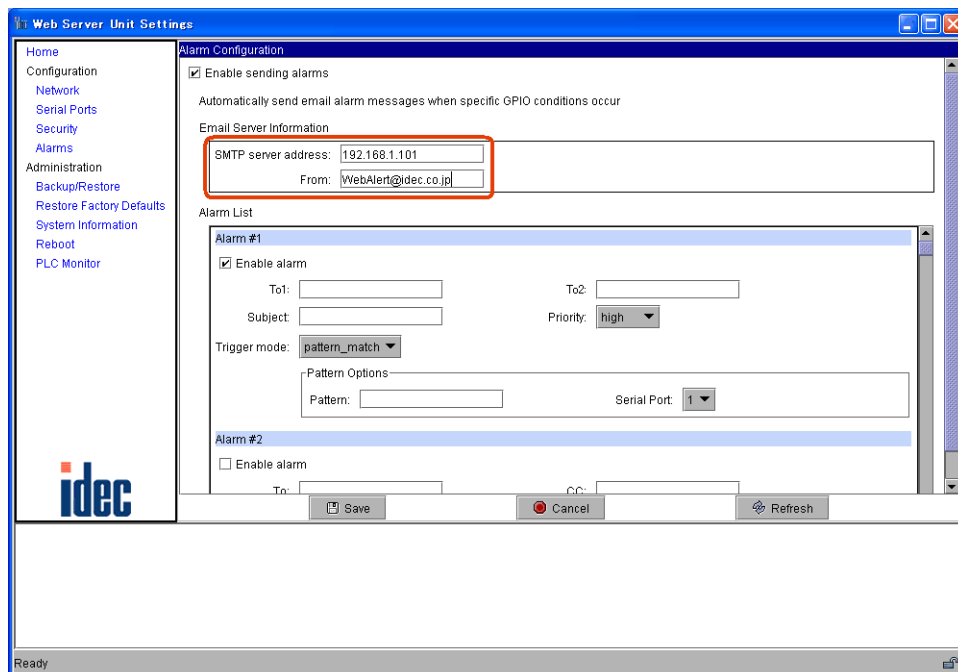

Mail server settings

3. Check the [Enable alarm] check box and enter the recipient mail address in the [To1:] field (and [To2:] field when sending to two addresses).

Web Server Unit Settings

Alarm Configuration

Enable sending alarms

Automatically send email alarm messages when specific GPIO conditions occur

Email Server Information

SMTP server address: 192.168.1.101

From: WebAlert@idec.co.jp

Alarm List

Alarm #1

Enable alarm

To1: admin@idec.co.jp To2:

Subject: Priority: high

Trigger mode: pattern\_match

Pattern Options

Pattern: Serial Port: 1

Alarm #2

Enable alarm

To: CC:

Save Cancel Refresh

Target address



**NOTE**

Recipient mail addresses

The total character number of target addresses, [To1:] plus [To2:], have to be within 64 characters.

4. Enter the message text in the [Subject] field.

Web Server Unit Settings

Alarm Configuration

Enable sending alarms

Automatically send email alarm messages when specific GPIO conditions occur

Email Server Information

SMTP server address: 192.168.1.101

From: WebAlert@idec.co.jp

Alarm List

Alarm #1

Enable alarm

To1: admin@idec.co.jp To2:

Subject: Temp. High Priority: high

Trigger mode: pattern\_match

Pattern Options

Pattern: Serial Port: 1

Alarm #2

Enable alarm

To: CC:

Save Cancel Refresh

Subject



**NOTE**

Messages ([Subject] field)

The total message length for a single message is up to 63 characters.

5. Select [pattern\_match], and enter the message send timing character string.

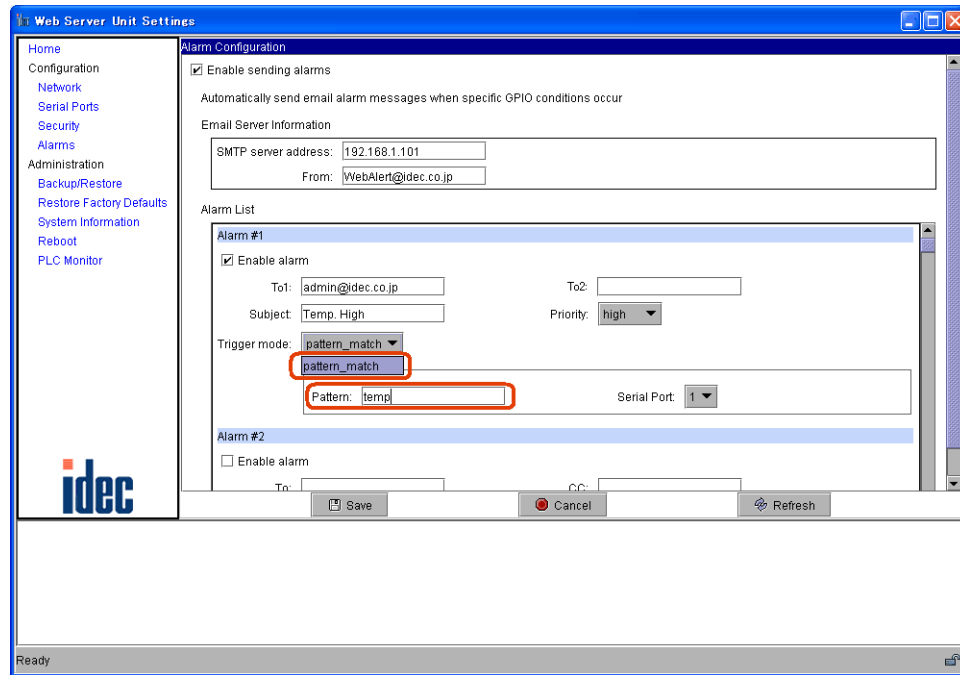

Mail send timing character string



#### NOTE Mail send timing character strings

The Web Server Unit can register up to 32 different messages. The send timing character string for each message must be unique.

6. Click the [Save] button, and the [Reboot] button on the left menu to complete the setting procedure.

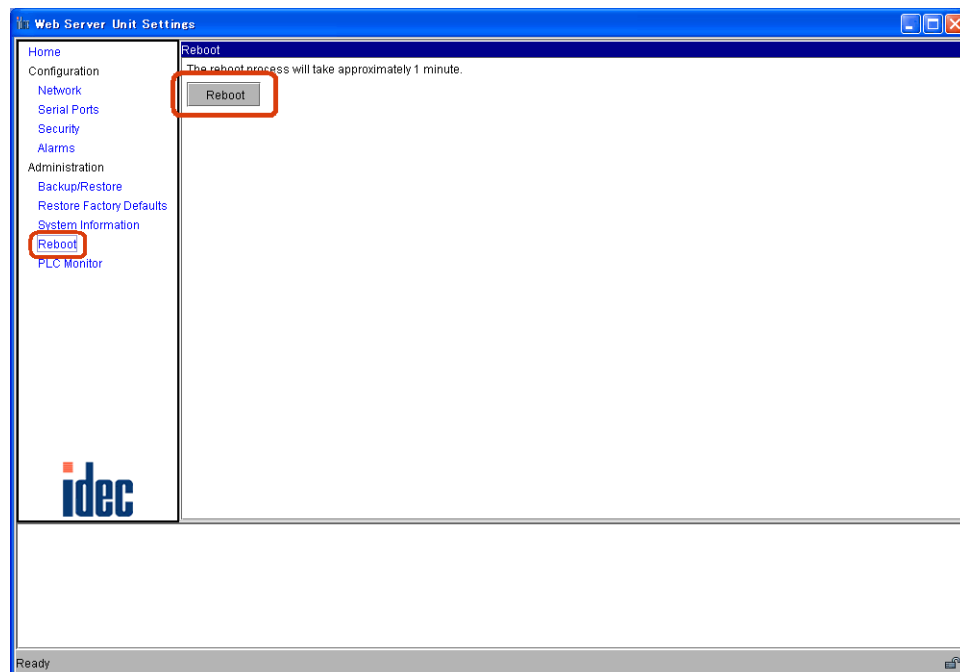

Reboot screen

## ■ MicroSmart Settings

MicroSmart user communication commands are used to send messages.

### ● User Communication Command Settings



**NOTE**

For more information on user communication, see Chapter 17, “User Communication Instructions” in the MicroSmart instruction manual.

1. Set the MicroSmart port for performing Ethernet user communication (1st or 2nd port). In WindLDR, select [Configuration] → [Function Area Settings] → [Communication] tab. Select the port to use for Ethernet user communication under [User Protocol].

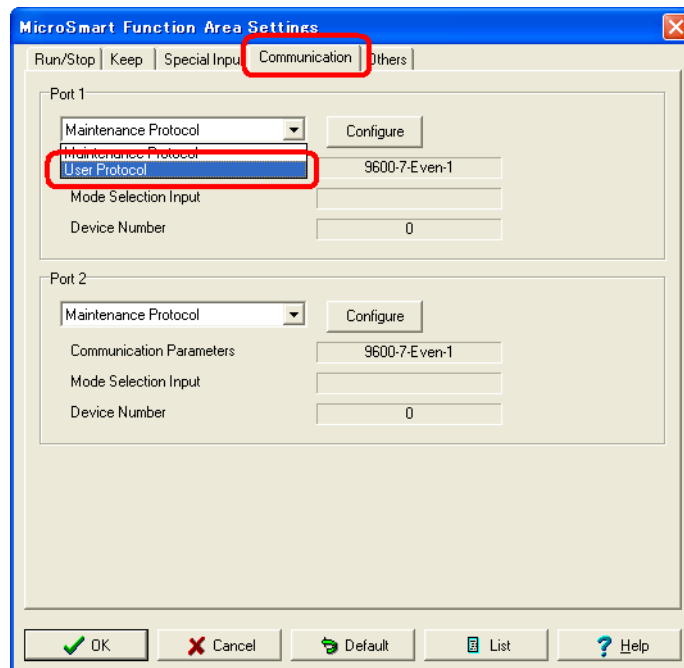

User protocol selection

2. Enter the user communication command in the ladder program.

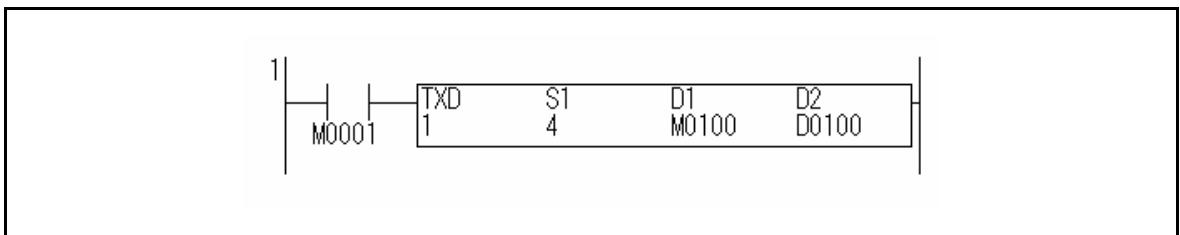

Example of communication command in a ladder program

Enter the TXD command in the ladder program.

- Download the ladder program.  
In WindLDR, select [Online] → [Download Program...] → [Download].



#### Web Server Unit settings and user communication command settings

Be sure to make the Web Server Unit's send timing character string (Pattern) the same as the MicroSmart TXD command data.

Pattern Options	
Pattern: <input type="text" value="temp"/>	Serial Port: <input type="text" value="1"/>

Example of character string for sending timing

## ■ Sample Program for sending messages

### ● System Configuration

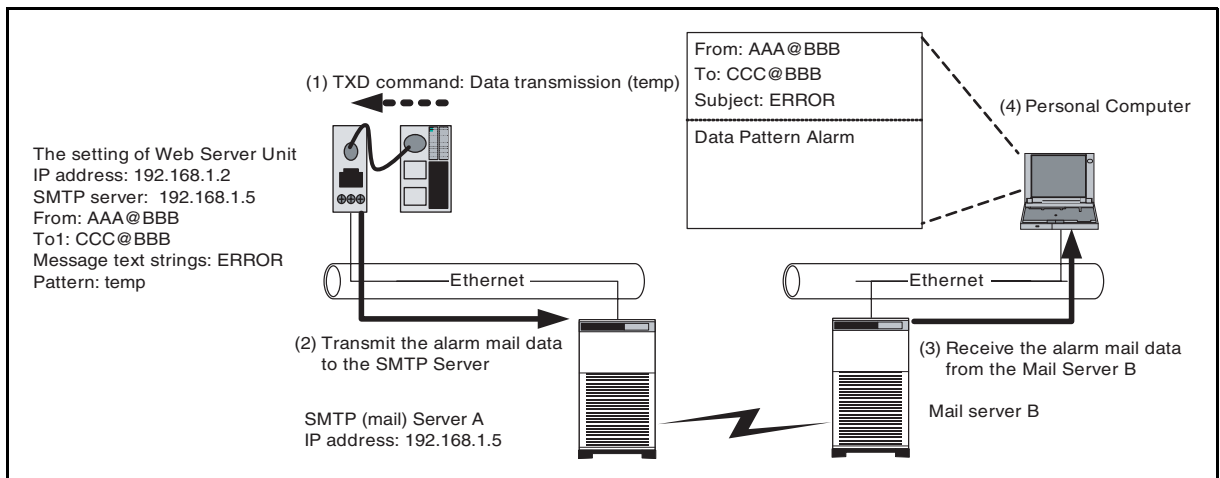

Example of sending a sample mail (System configuration)

MicroSmart:

- 1) MicroSmart transmits data (the alphanumeric characters: temp) with the TXD command.

Web Server Unit:

- 2) Web Server Unit compares data transmitted from MicroSmart with the pattern that is registered. If data are corresponding with it, Web Server Unit transmits the alarm mail data that is registered to the SMTP server.

Mail server:

- 3) Mail server transmits the alarm mail data sent from Web Server Unit to the targeted mail address.

Personal Computer:

- 4) The personal computer receives the mail in which the subject is used as a message character string. This string is registered to the Web Server Unit in advance.

### ● Sample Ladder Program

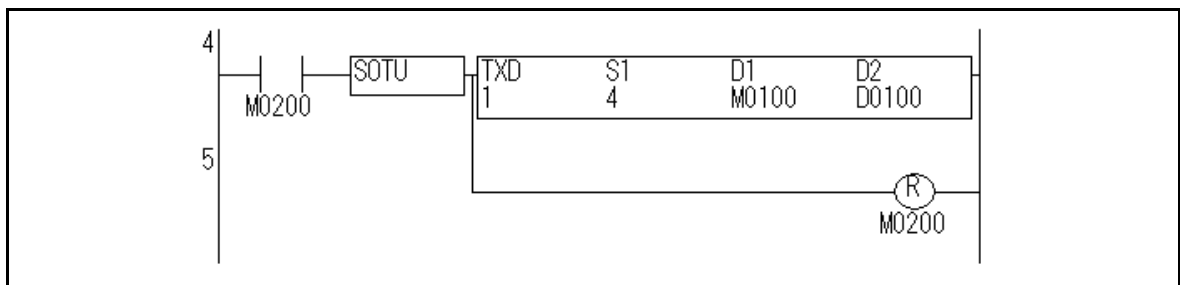

If the start input M0200 is turned on, MicroSmart transmit the character string of “temp” from its port 1.

# CONNECTION DIAGRAM

## ■ PLC connecting cable (Model No.: FC4A-KC3C, Cable Length : 10cm)

### ● The external of cable

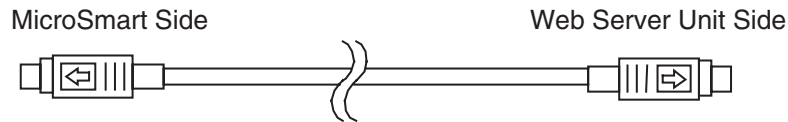

### ● The pin layout of connectors

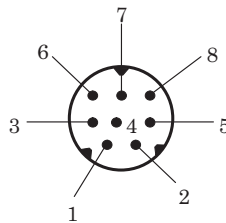

### ● The connection diagram of cable

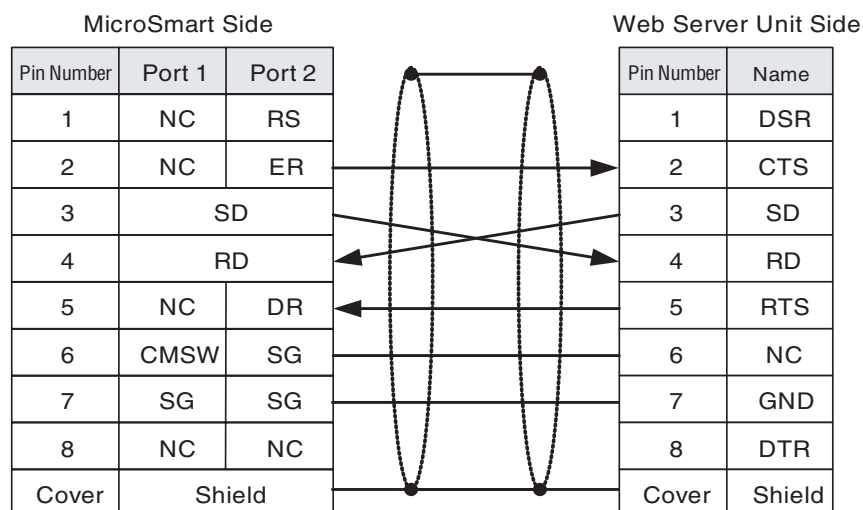

# TROUBLESHOOTING

## ■ The following troubles and solutions could be considered

- When power display LED (PWR) does not go on

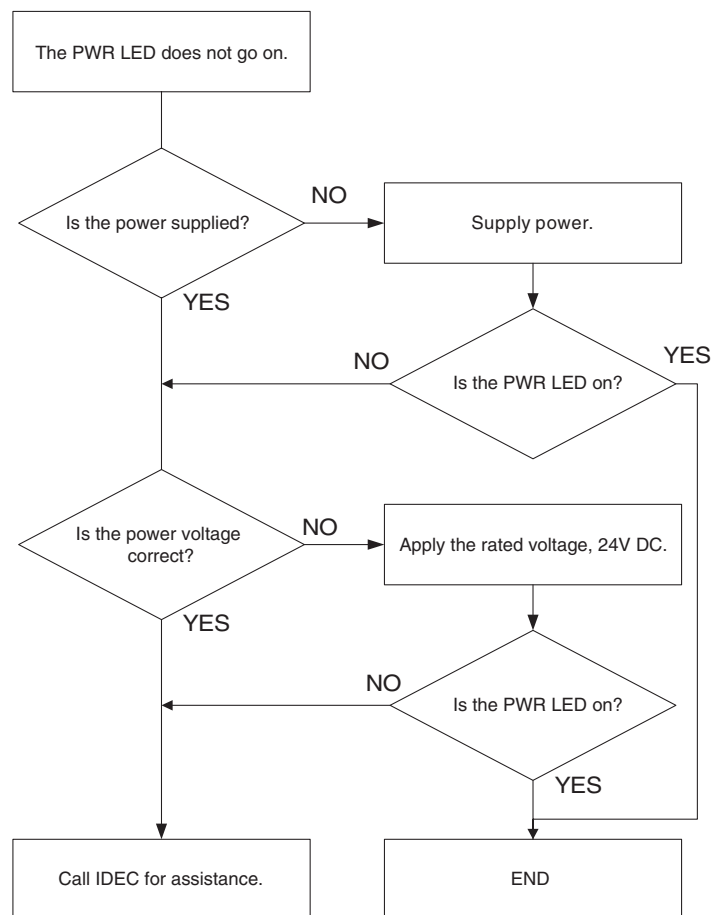

● It is not possible to communicate with WindLDR

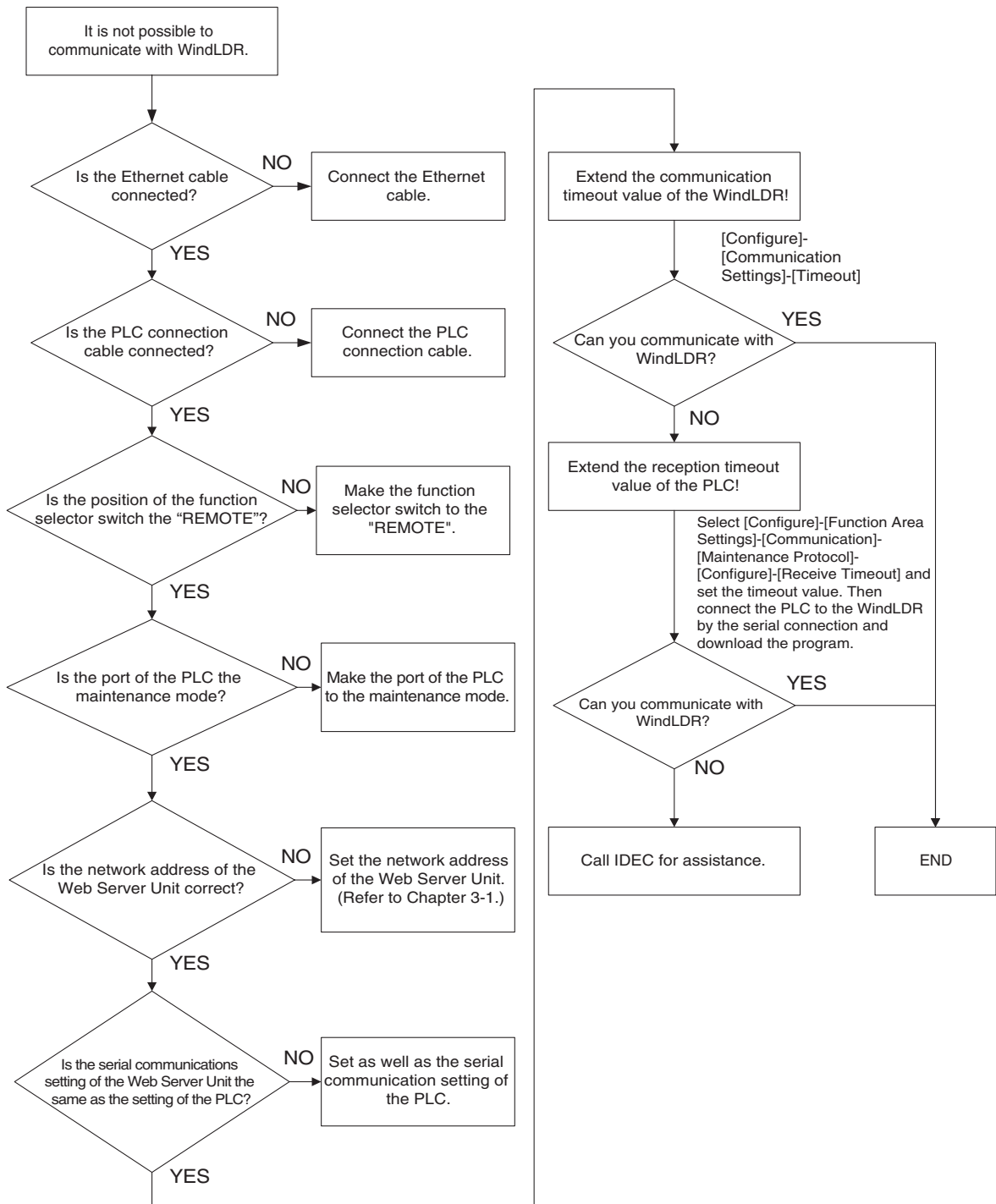

● Ethernet user communication does not operate normally

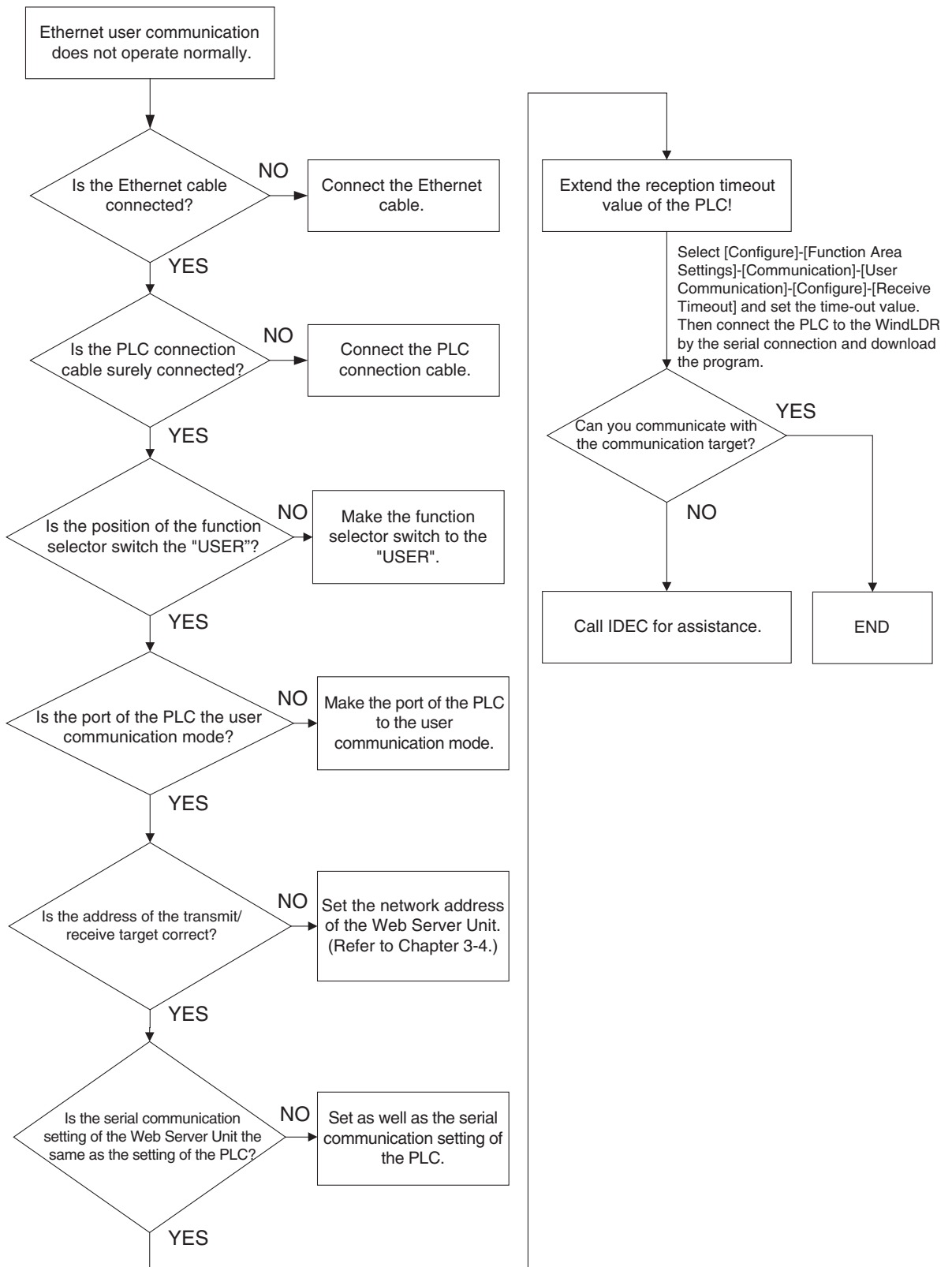

● When the alarm mail is not transmitted

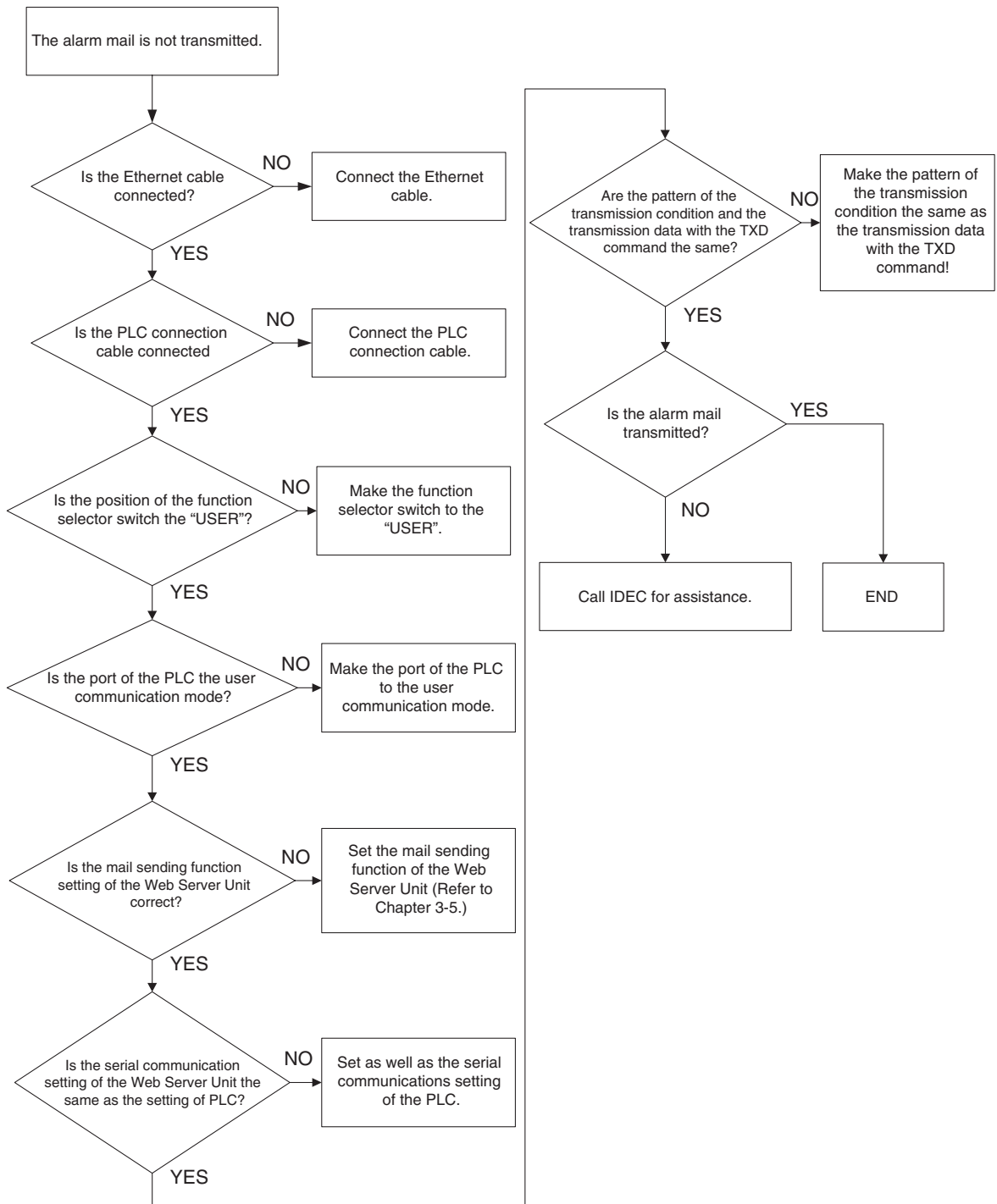

# GLOSSARY

---

## **ICMP (Internet Control Message Protocol)**

An IP-layer protocol used to transfer error messages and control messages. Used for mutual status confirmation between computers or network devices connected by TCP/IP.

## **DHCP (Dynamic Host Configuration Protocol)**

A method of dynamically assigning IP addresses to network devices on a LAN. The DHCP server dynamically assigns a single preset IP address to each network device when the device starts.

## **IP (Internet Protocol) address**

The 32-bit address information used to identify each device on a TCP/IP network. IP addresses are unique numbers assigned to devices that use IP to communicate. They are used to specify the recipient device when exchanging data.

## **Subnet mask**

The mask value used when requesting a subnet network address from an IP address. The IP address and subnet mask are combined by an AND operation to obtain the subnet address. The IP address is divided into a network address No. and host address No., and the network address is further divided into the subnet.

## **Port No.**

An auxiliary address created at a lower level than the IP address, used to connect multiple recipients at the same time during TCP/IP communication. Numbers from 0 to 65535 are used to specify ports. Data is sent/received using the combination of IP address and port No.

## **TCP (Transmission Control Protocol)**

The standard protocol used on the Internet. Corresponds to the OSI (Open Systems Interconnection) reference model transport layer. Bridges the network-layer IP and protocols above the session layer (such as HTTP, FTP, SMTP and POP).

## **HTTP (Hypertext Transfer Protocol)**

The protocol used between the Web browser and Web server to send and receive data such as HTML files.

## **SMTP (Simple Mail Transfer Protocol)**

The protocol used to send email on a TCP/IP network.

## **Java**

An object-oriented interpreter language developed by Sun Microsystems, Inc.

## **JavaScript**

A script language developed by Netscape Communications Corporation. Based on Netscape's LiveScript. Incorporates some Java features.

## **Java VM**

An environment for interpreting/executing programs using intermediate codes generated by a Java compiler.

## **Java applets**

Java programs downloaded from the network by the Web browser, and embedded in and executed by browser windows.



# INDEX

---

<b>A</b>		
Alarms		
Sending alarms .....	3-32	
<b>B</b>		
Backup .....	3-8	
<b>C</b>		
Communication between MicroSmart modules	3-27	
Communication settings		
WindLDR .....	3-11	
Connection port .....	2-2	
Cross-cable .....	3-2	
<b>D</b>		
DHCP server .....	3-6	
<b>E</b>		
Ethernet user communication .....	3-21	
<b>F</b>		
Function selector switch .....	2-2	
<b>J</b>		
Java applets .....	3-14	
<b>L</b>		
LINK LED .....	2-2	
<b>M</b>		
Mail send timing .....	3-34	
Mail sending function .....	3-29	
Mail server .....	3-29	
Messages .....	3-30, 3-33	
<b>N</b>		
Network address .....	3-2	
Network address setting .....	3-5	
Network LED .....	2-2	
<b>O</b>		
OPC server .....	3-13	
Other function .....	3-2	
<b>P</b>		
PLC Monitor .....	3-8	
PLC operand monitor .....	3-18	
Power display LED .....	2-2	
<b>R</b>		
Reboot .....	3-8	
Recipient mail addresses .....	3-33	
Remote maintenance .....	3-10, 3-13	
Restore .....	3-8	
Restore Factory Defaults .....	3-8	
<b>S</b>		
SCADA .....	3-13	
Security .....	3-8	
Java applet .....	3-4	
Password .....	3-13	
Serial communication .....	3-2	
Serial communication setting .....	3-7	
System configuration .....	3-2	
System Information .....	3-8	
System Setting Screen		
Web browser .....	3-22	
WindLDR .....	3-3, 3-22	
<b>T</b>		
TCP client mode .....	3-23	
Always .....	3-24	
When data present on serial line .....	3-24	
Timeout .....	3-13	
<b>U</b>		
User communication		
Sending messages .....	3-35	
User communication command .....	3-26	
User screen .....	3-20	
<b>W</b>		
Web server function .....	3-14	
WindLDR .....	3-11	

# MICRO**Smart Web Server Unit** Instruction Manual

---

- FC9Y-B919
- Issued: June 2005, First Edition
- 1-7-31 Nishi-Miyahara, Yodogawa-ku, Osaka, Japan

**IDEC IZUMI CORPORATION**

© Copyright IDEC IZUMI CORPORATION

---

- Specifications and other information in this manual are subject to change without prior notice.
- Unauthorized reprinting is prohibited.



## JAPAN

IDEC IZUMI CORPORATION  
7-31, Nishi-Miyahara 1-Chome,  
Yodogawa-ku, Osaka 532-8550, Japan  
Tel: +81-6-6398-2571  
Fax: +81-6-6392-9731  
[www.idec.com](http://www.idec.com)

## UNITED STATES

IDEC CORPORATION  
1175 Elko Drive, Sunnyvale, CA 94089-2209, USA  
Tel: +1-408-747-0550  
Toll Free: (800) 262-IDEC  
Fax: +1-408-744-9055  
Fax: +1-800-635-6246  
E-mail: [opencontact@idec.com](mailto:opencontact@idec.com)  
[www.idec.com](http://www.idec.com)

## CANADA

IDEC CANADA LIMITED  
Unit 22-151 Brunel Road,  
Mississauga, Ontario, L4Z 1X3, Canada  
Tel: +1-905-890-8561  
Toll Free: (888) 317-4332  
Fax: +1-905-890-8562

## AUSTRALIA

IDEC AUSTRALIA PTY. LTD.  
2/3 Macro Court, Rowville, Victoria 3178, Australia  
Tel: +61-3-9763-3244  
Toll Free: 1800-68-4332  
Fax: +61-3-9763-3255  
E-mail: [sales@au.idec.com](mailto:sales@au.idec.com)

## UNITED KINGDOM

IDEC ELECTRONICS LIMITED  
Unit 2, Beechwood, Chineham Business Park, Basingstoke,  
Hampshire RG24 8WA, United Kingdom  
Tel: +44-1256-321000  
Fax: +44-1256-327755  
E-mail: [idec@uk.idec.com](mailto:idec@uk.idec.com)

## GERMANY

IDEC ELEKTROTECHNIK GmbH  
Wendenstrasse 331, D-20537 Hamburg, Germany  
Tel: +49-40-25 30 54 - 1  
Fax: +49-40-25 30 54 - 24  
E-mail: [service@idec.de](mailto:service@idec.de)

## HONG KONG

IDEC IZUMI (H.K.) CO., LTD.  
Unit 1505-07, DCH Commercial Centre No. 25,  
Westlands Road, Quarry Bay, Hong Kong  
Tel: +852-2803-8989  
Fax: +852-2565-0171  
E-mail: [idec@idechk.com](mailto:idec@idechk.com)

## CHINA

IDEC IZUMI (Shanghai) Co., Ltd.  
Room 608-609, 6F, Gantai Plaza, No. 700  
Yan'an East Rd, Shanghai, China  
Tel: +86-21-5353-1000  
Fax: +86-21-5353-1263  
E-mail: [idec@cn.idec.com](mailto:idec@cn.idec.com)

## TAIWAN

IDEC TAIWAN CORPORATION  
8F-1, No. 79, Hsin Tai Wu Road, Sec. 1, Hsi-Chih,  
Taipei County, Taiwan  
Tel: +886-2-2698-3929  
Fax: +886-2-2698-3931  
E-mail: [service@idectwn.com.tw](mailto:service@idectwn.com.tw)

## SINGAPORE

IDEC IZUMI ASIA PTE. LTD.  
No. 31, Tannery Lane #05-01  
Dragon Land Building, Singapore 347788  
Tel: +65-6746-1155  
Fax: +65-6844-5995  
E-mail: [generalinfo@idecasia.com.sg](mailto:generalinfo@idecasia.com.sg)

©2005 IDEC IZUMI CORPORATION. All Rights Reserved.  
B919-(0) Printed in Japan 06/2005