

---

(RS-232/422/485)

# Vlinx Wireless Serial Servers

Models:

*ESR901W232, ESR901W485,*

*ESR902W, ESR904W*



**B&B electronics**  
MANUFACTURING COMPANY

---

Documentation Number: ESR90xW-4905m pn#6876-rev001

B&B Electronics Mfg Co Inc – 707 Dayton Rd - PO Box 1040 - Ottawa IL 61350 - Ph 815-433-5100 - Fax 815-433-5104 – [www.bb-elec.com](http://www.bb-elec.com)  
B&B Electronics Ltd – Westlink Commercial Park – Oranmore, Galway, Ireland – Ph +353 91-792444 – Fax +353 91-792445 – [www.bb-europe.com](http://www.bb-europe.com)

---

Documentation Number: ESR90xW-4905m

B&B Electronics Mfg Co Inc – 707 Dayton Rd - PO Box 1040 - Ottawa IL 61350 - Ph 815-433-5100 - Fax 815-433-5104 – [www.bb-elec.com](http://www.bb-elec.com)  
B&B Electronics Ltd – Westlink Commercial Park – Oranmore, Galway, Ireland – Ph +353 91-792444 – Fax +353 91-792445 – [www.bb-europe.com](http://www.bb-europe.com)



**International Headquarters**

B&B Electronics Mfg. Co. Inc.

707 Dayton Road

Ottawa, IL 61350 USA

**Phone** (815) 433-5100 -- **General Fax** (815) 433-5105

Website: [www.bb-elec.com](http://www.bb-elec.com)

**Sales** e-mail: [orders@bb-elec.com](mailto:orders@bb-elec.com) -- **Fax** (815) 433-5109

**Technical Support** e-mail: [support@bb.elec.com](mailto:support@bb.elec.com) -- **Fax** (815) 433-5104

**European Headquarters**

B&B Electronics Ltd.

Westlink Commercial Park

Oranmore, Co. Galway, Ireland

**Phone** +353 91-792444 -- **Fax** +353 91-792445

Website: [www.bb-europe.com](http://www.bb-europe.com)

**Sales** e-mail: [sales@bb-europe.com](mailto:sales@bb-europe.com)

**Technical Support** e-mail: [support@bb-europe.com](mailto:support@bb-europe.com)

© B&B Electronics – November 2005

---

Documentation Number: ESR90xW-4905m pn#6876-rev001

B&B Electronics Mfg Co Inc – 707 Dayton Rd - PO Box 1040 - Ottawa IL 61350 - Ph 815-433-5100 - Fax 815-433-5104 – [www.bb-elec.com](http://www.bb-elec.com)  
B&B Electronics Ltd – Westlink Commercial Park – Oranmore, Galway, Ireland – Ph +353 91-792444 – Fax +353 91-792445 – [www.bb-europe.com](http://www.bb-europe.com)

---

© 2005 B&B Electronics. No part of this publication may be reproduced or transmitted in any form or by any means, electronic or mechanical, including photography, recording, or any information storage and retrieval system without written consent. Information in this manual is subject to change without notice, and does not represent a commitment on the part of B&B Electronics.

B&B Electronics shall not be liable for incidental or consequential damages resulting from the furnishing, performance, or use of this manual.

All brand names used in this manual are the registered trademarks of their respective owners. The use of trademarks or other designations in this publication is for reference purposes only and does not constitute an endorsement by the trademark holder.

---

Documentation Number: ESR90xW-4905m

B&B Electronics Mfg Co Inc – 707 Dayton Rd - PO Box 1040 - Ottawa IL 61350 - Ph 815-433-5100 - Fax 815-433-5104 – [www.bb-elec.com](http://www.bb-elec.com)  
B&B Electronics Ltd – Westlink Commercial Park – Oranmore, Galway, Ireland – Ph +353 91-792444 – Fax +353 91-792445 – [www.bb-europe.com](http://www.bb-europe.com)

# Table of Contents

<b>CHAPTER 1: INTRODUCTION.....</b>	<b>1</b>
ABOUT YOUR VLINX ESR90xW WIRELESS SERIAL SERVER .....	1
<i>Features</i> .....	2
<i>Communication Modes</i> .....	2
802.11 WIRELESS NETWORKING BASICS .....	3
<i>802.11 Wireless Networking</i> .....	4
ESR90xW STARTUP PROCEDURE.....	6
1. <i>Package Checklist</i> .....	6
2. <i>Hardware Setup</i> .....	6
3. <i>Power Up</i> .....	7
4. <i>Set Up PC</i> .....	8
5. <i>Configuration</i> .....	8
6. <i>Operation</i> .....	8
<b>CHAPTER 2: VLINX ESR90xW HARDWARE .....</b>	<b>9</b>
PACKAGE CHECKLIST .....	9
HARDWARE FEATURES .....	10
<i>Indicators</i> .....	10
<i>Reset Switch</i> .....	10
<i>Connectors</i> .....	11
<i>RS-485 Receiver Biasing</i> .....	12
<i>RS-422/485 Terminating</i> .....	12
CONNECTIONS FOR SERVER CONFIGURATION.....	12
OTHER HARDWARE CONNECTIONS.....	13
<b>CHAPTER 4: DEVICE CONFIGURATION VIA WEB CONSOLE.....</b>	<b>15</b>
ACCESSING THE WEB BROWSER .....	15
CONFIGURING THE SERIAL PORT .....	16
CONFIGURING COMMUNICATIONS MODES AND PROTOCOLS .....	16
CONFIGURING NETWORK PROPERTIES .....	17
CONFIGURING WIRELESS PROPERTIES .....	17
MANAGING USERS ACCOUNTS .....	18
USING DEVICE STATUS INFORMATION .....	19

<b>CHAPTER 5: ADJUSTING THE BEHAVIOR OF DEVICE COMMUNICATION PORTS .....</b>	<b>21</b>
POLLING STRINGS.....	22
TIMEOUTS.....	22
DATA QUANTITIES.....	22
USING MULTIPLE CONDITIONS .....	22
<b>CHAPTER 6: DEVICE DISCOVERY AND VIRTUAL COM PORTS .....</b>	<b>23</b>
DEVICE DETECTION UTILITY .....	23
VCOM PORT SETUP .....	24
<b>APPENDIX A: VLINX ESR90xW TECHNICAL DATA .....</b>	<b>25</b>
PRODUCT SPECIFICATIONS.....	25
DEFAULT SERVER PROPERTIES.....	27
VLINX ESR90xW DIMENSIONAL DIAGRAMS .....	28
<b>APPENDIX B: RS-232/422/485 CONNECTIONS.....</b>	<b>31</b>
DB-9 PIN-OUTS FOR RS-232 AND RS-232/422/485 CONNECTIONS .....	31
TERMINAL BLOCK PIN-OUT FOR RS-422 AND RS-485 (VLINX ESR901W485 ONLY) .....	32
<b>APPENDIX C: CONFIGURATION PORT CONNECTIONS .....</b>	<b>35</b>
RJ-45 PIN-OUT FOR CONFIGURATION PORT CONNECTION.....	35
<b>DECLARATION OF CONFORMITY .....</b>	<b>357</b>

## Chapter 1: Introduction

### Thank you for purchasing a Vlinx ESR90xW Wireless Serial Server!

Like all B&B Electronics products, your serial server has been manufactured to high standards of quality and performance to ensure your complete satisfaction. Please read this manual and carefully follow the instructions to achieve best results. For additional information on this and other B&B products, and for technical support, and for technical support, call 815-433-5100 option 3, or access B&B Electronics' website at: [www.bb-elec.com](http://www.bb-elec.com)

### About Your Vlinx ESR90xW Wireless Serial Server

Vlinx ESR90xW Wireless Serial Servers are part of B&B Electronics growing family of device servers, products that allow you to connect equipment with available serial connections into existing networks. Vlinx ESR90xW wireless serial servers connect RS-232, RS-422 or RS-485 devices to a wireless network via wireless access points, eliminating the need for network cabling. Devices connected to the serial ports on your Vlinx ESR90xW can be accessed from any node on the LAN using **Direct IP Mode**, **Virtual COM Port**, or **Serial Tunneling** (Paired Mode) connections. Based on the 802.11g wireless standard, Vlinx ESR90xW servers operate at up to 54Mbps over the 2.4 GHz band, which does not require licensing.



Vlinx ESR90xW Wireless Serial Servers (*ESR902W shown*)

Vlinx ESR90xW wireless serial servers are built for use in industrial environments and feature rugged DIN or panel mountable enclosures. They operate from AC or DC power supply voltages and feature removable screw terminal power connectors.

### Features

- **Backward compatibility** with 802.11b (up to 11 Mbps)
- **Multi-interface serial ports**
  - The Vlinx 901W232 features one RS-232 serial port using a standard DB-9M connector
  - The Vlinx 901W485 features one RS-422/485 serial port using a removable terminal block connector
  - The Vlinx 902W features two serial ports (one RS-232 and one software-selectable RS-232/422/485) using DB-9M connectors
  - The Vlinx 904W features four serial ports (two RS-232 and two software-selectable RS-232/422/485) using DB-9M connectors
- **Rugged DIN rail or panel mountable IP30 enclosure**
- **Accepts AC or DC power over a wide voltage range**
- **LAN and WAN Communications via wireless access point**
- **TCP or UDP Client or Server operation** - configurable
- **Software Support** - Windows 98/ME/2000/XP or NT 4.0
- **Field upgradeable**
- **Configuration** of wireless and serial port settings using:
  - **Vlinx Web Console**, which allows configuration via the network using a web browser.

### Communication Modes

Vlinx ESR90xW Wireless Serial Servers enable communication with serial devices over a wireless network. The three main types of communications supported by ESR90xW Wireless Serial Servers are **Direct IP Mode**, **Virtual COM Mode** and **Serial Tunneling Mode**.

#### Direct IP Mode

**Direct IP** connections allow applications using TCP/IP or UDP/IP socket programs to communicate with the asynchronous serial ports on the serial server. In this type of application the serial server is configured as a TCP or UDP server. The socket program running on the PC establishes a communication connection. The data is sent directly to and from the serial port on the server. When using UDP protocol the server can be configured to broadcast data to and receive data from multiple IP addresses.

## Virtual COM Mode

**Virtual COM Mode** allows application programs to effectively extend their COM ports across the network. Data sent to that port is redirected via the network to a COM port on the serial server. Windows programs using standard Windows API calls are able to interface to these virtual COM ports. When a program on the PC opens the port, it communicates with the remote serial device connected to one of the ports on the serial server.

After connection, the LAN is transparent to the program and serial device. Applications are able to work just as if the serial device is connected directly to a physical COM port on the computer. The virtual COM port software converts the application's data into IP packets, sends it across the network to the serial server, which converts the IP packet back to serial data and sends the data out a serial port located on the serial server.

## Serial Tunneling Mode

**Serial Tunneling** is also called *paired mode*. In this mode any two serial devices that can communicate across the wireless link will be able to communicate using two serial servers.

One server is configured as a TCP or UDP client and the other as a TCP/UDP server. When setting up the server the remote IP address section must contain the address of the client. This will allow the client's IP address to pass the IP address-filtering feature of the server. Conversely, the Remote IP address of the client must contain the server's IP address. Both communication port numbers must be the same.

## 802.11 Wireless Networking Basics

**Vlinx ESR90xW wireless serial servers** allow you to connect non-network-enabled serial devices into a wireless network, giving you the capability to gather more data and implement remote programming and management. Serial devices no longer are limited to a physical connection to a PC. The serial device can be connected to a Vlinx ESR90xW wireless serial server anywhere within range of an 802.11g compatible wireless access point. Communication occurs transparently using TCP/IP or UDP/IP over a wireless link. This allows traditional Windows PC software access to serial devices anywhere on the wireless network.

The enabling technology for Vlinx ESR90xW wireless serial servers is based on the IEEE 802 standard. Some background on the standard follows.

## 802.11 Wireless Networking

**IEEE 802.11** is a set of standards that defines how multiple devices can communicate on a wireless network. The standard has grown into a set of several standards that define various features and functions. The 802.11g standard defines the physical and data link layers for a wireless network using the 2.4 GHz frequency band, a band that does not require licensing. As a part of the IEEE family of standards, 802.11 WLANs are easily connected to 802.3 (Ethernet) LANs. Higher layer LAN protocols, network operating systems and internetworking protocols such as TCP/IP integrate seamlessly.

Under the IEEE 802.11 standard there can be two different types of devices on the wireless network: *stations* and *access points (AP)*. A **station** often is a PC equipped with a wireless network adapter. An 802.11 **access point** is a radio with an interface that allows connection to a wired LAN. Access points run bridging software to facilitate the connection from wireless to wired network. The access point becomes the base station for the WLAN. It aggregates access to the wired network for multiple wireless stations. An access point may be a standalone device or a card in a PC.

## Wireless Network Configurations

The 802.11 standard defines two modes of operation: *infrastructure mode* and *ad hoc mode*. **Infrastructure mode** makes use of one or more access points connected to a wired LAN. Wireless stations communicate with access points to gain access to each other and/or the LAN. In the Basic Service Set (BSS) several stations communicate with one access point, which is connected to a wired LAN. In the Extended Service Set (ESS) two or more access points connect to the LAN creating a subnetwork.

**In ad hoc mode**, also called Independent Basic Service Set (IBSS), access points are not used. Wireless stations communicate directly with each other in a peer-to-peer fashion. This mode allows individual computers to set up a network where wireless infrastructure does not exist.

Vlinx ESR90xW wireless serial servers can be configured to operate in infrastructure mode only, ad hoc mode is not supported at this time. During device configuration a wireless configuration wizard guides you through the process of setting up the type of network, naming the network (specifying the SSID, or service set identifier) and other parameters.

## IEEE 802.11g

IEEE 802.11g standard specifies a WLAN that operates on the 2.4 GHz band at data rates up to 54 Mbps, but is backward compatible with the earlier 802.11b standard (which operates at up to 11 Mbps). Systems can incorporate 802.11b and 802.11g equipment and they will interoperate. However, when connected into the same network the 802.11g equipment will operate at the 11 Mbps limitation of the 802.11b equipment.

For media access, 802.11 wireless networks use CSMA/CA, a scheme in which a station that intends to transmit 'listens' for traffic on the radio carrier frequency and sends data packets if the frequency is clear. If the receiving station receives the packet intact it sends an acknowledgement (ACK) to confirm the packet has been received. If the transmitting station does not receive an ACK it assumes a collision occurred and transmits again after a random delay period.

Communications distances vary depending on the type and thickness of material around an 802.11g node. The transmitter power output, the type of antenna used and the amount of attenuation through materials also affects the useable range. Electromagnetic noise, reflections, the amount of network traffic, other radio devices operating in the same frequency band also affect range and overall performance. In an infrastructure network the number of access points and their coverage pattern also affect how well the system operates. Typically an 802.11 device operating indoors will have a range from 100 feet minimum to about 300 feet maximum. Outdoors, some products, using high gain antennae may achieve line-of-sight ranges of five miles or more.

Security is a significant concern for WLAN users. Whether security threats originate intentionally or unintentionally, wireless systems are more susceptible than wired systems. Vlinx ESR90xW offer several security options including WEP (Wired Equivalent Privacy), LEAP (Lightweight Extensible Authentication Protocol) and others.

## ESR90xW Startup Procedure

Setup and configuration of your Vlinx ESR90xW wireless serial server is fast, straightforward and simple. You have several options from which to choose. The following procedure outlines an easy way to get your server set up and operational.

### 1. Package Checklist

To begin, check to see that you have everything you will require. The contents of your ESR90xW package should include:

- One Vlinx ESR901W232, ESR901W485, ESR902W or ESR904W Wireless Serial Server
- One SMA antenna
- One Operation Manual
- One Quick Start Guide
- One CD containing
  - Device Detection software
  - Serial-IP Virtual COM Port Software
  - the Operation Manual (in pdf format)
  - the Quick Start Guide (in pdf format)

### 2. Hardware Setup

1. Connect the antenna to your ESR90xW
2. Connect a standard Ethernet (CAT5/RJ-45 straight through) cable from the PC network adapter to the ESR90xW Configuration Port
3. Connect 24 VAC or 12 to 30 VDC power to the ESR90xW
4. Connect the serial port on the ESR90xW to the serial port on your serial device. This is optional during the initial configuration steps but will be required for operation.

*For RS-232 operation, your ESR90xW is configured as a DTE and uses a DB-9M connector. Use a straight through RS-232 cable if your serial device is configured as a DCE. If your serial device is configured as a DTE you will have to use a null modem (crossover) cable.*

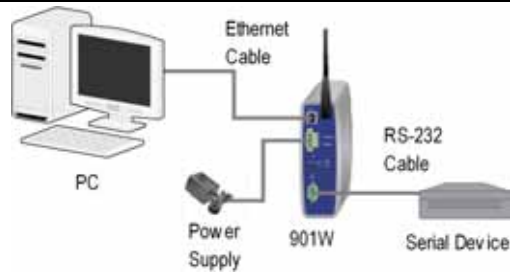

Figure 1. Direct Connection for Configuration

### 3. Power Up

1. Apply power to the ESR90xW
2. Front panel LED will illuminate with the following sequence:
  - a. Power LED will always be lit while device is powered
  - b. Signal Strength LED – White for 5 seconds, blink yellow/Red and go dark.
  - c. The Link/Activity LED will be red when the device is associating with an access point (if configured to do so)
  - d. The Link/Activity LED will be green when the device is associated with an access point (if configured to do so)

**Note:** The device by default is not configured to associate with an access point

#### Operating System Boot Completion Indication

- e. Once the device has booted successfully into the operating system all of the LEDs with the exception of Power will blink once to indicate a completed boot sequence.
- f. When this sequence starts all of the LEDs will be lit for one half of a second after which they will resume their previous state.

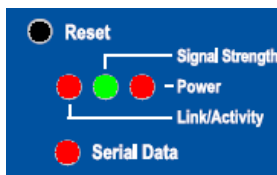

Figure 2. ESR90xW LEDs

### 4. Set Up PC

1. Configure the PC to work in the 192.168.0.x private address range
2. Open a web browser
3. Enter 192.168.0.200 into the address bar of the browser



Figure 3. Web Console Device Information Page

### 5. Configuration

1. Enter your **Username** and **Password** to Login. The default username is “Administrator” with no password.
2. Navigate to Wireless Settings, provide SSID name, configure security settings
3. Navigate to Serial Configuration, set up serial parameters to match your serial device
4. Click Apply and restart the ESR90xW

### 6. Operation

1. ESR90xW will boot up and attempt to connect to the designated access point
2. The Link LED will light when it makes the connection
3. Communications will occur between the PC and serial device

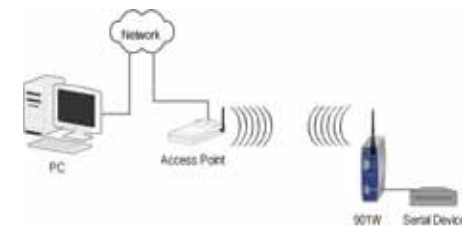

Figure 4. Infrastructure Mode Operation

## Chapter 2: Vlinx ESR90xW Hardware

### Package Checklist

Vlinx ESR90xW Wireless Serial Servers are shipped with the following items included:

- ✓ A Vlinx ESR901W232, ESR901W485, ESR902W or ESR904W Wireless Serial Server
- ✓ This Operation Manual
- ✓ CD-ROM disc with Device Detection Software and Serial/IP™ for Windows 98/ME/2000/XP/NT 4.0, Operation Manual and Quick Start Guide (in pdf format)

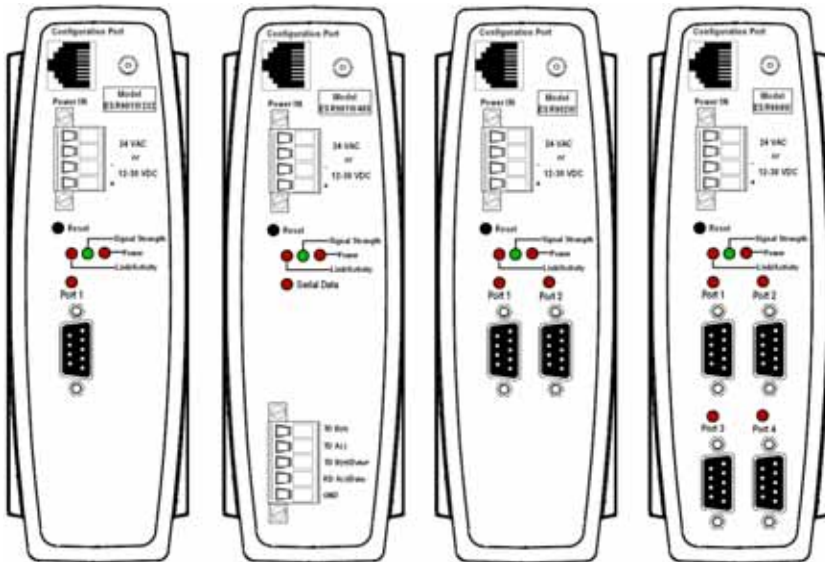

Figure 5. Front View of the Vlinx ESR901W232, ESR901W485, ESR902W and ESR904W Wireless Serial Servers

## Hardware Features

### Indicators

#### Power LED

**Red:** Indicates the device is receiving power from an external source

#### Signal Strength LED

**Tri-color:** Indicates the connection quality:

- **Dark:** no connection or 0% signal strength
- **Red:** poor signal, represents 1% to 60% signal strength
- **Blue:** acceptable signal, represents 61% to 85% signal strength
- **Green:** good signal, represents 86% to 100% signal strength

#### Link/Activity LED

- **Dark:** no wireless connection is being attempted
- **Solid Red:** Indicates that a connection to a wireless access point or device is being attempted.
- **Blinking Red:** When link is established, LED blinks.
- **Solid Green:** Indicates that a connection to a wireless access point or device has been established.
- **Green With Red:** Red flashes on and off when data is present on the wireless network.

#### Serial Port LEDs (for each port)

- **Blinking Red:** Indicates the serial port is communicating.

### Reset Switch

The **Reset** switch is a recessed switch located on the front of the Vlinx ESR90xW. It can perform more than one function:

- **Press 0 to 1 second:** no effect
- **Press and hold 1 to 10 seconds:** reset serial server operating system
- **Press and hold 10+ seconds:** reset serial server to factory default settings.

## Connectors

### Configuration Port Connector

One standard RJ-45 receptacle that allows the serial server to be connected to personal computer for programming, troubleshooting and device configuration. A standard straight-through RJ-45 (male) Ethernet cable can be used for this purpose. (This port is not intended to connect directly to an Ethernet network.)

### Antenna Connector

The antenna connector is a reverse SMA connector.

(An omni-directional antenna is supplied with ESR90xW wireless serial servers. All ESR90xW serial servers are FCC-certified when the supplied antenna is used.)

### Serial Port Connector(s)

- **ESR901W232:** One DB-9M connector
- **ESR901W485:** One five-terminal removable terminal block
- **ESR902W:** Two DB-9M connectors
  - **Port 1:** RS-232
  - **Port 2:** software selectable for RS-232, RS-422 or RS-485
- **ESR904W:** Four DB-9M connectors
  - **Ports 1 & 3:** RS-232
  - **Ports 2 & 4:** software selectable for RS-232, RS-422 or RS-485

### Power Connector

The power connector is a removable terminal block with four terminals. From top to bottom the terminals are:

Terminal Number	Terminal Name	Connect to	Description
1	AC In	One side of AC power supply (if AC power used)	24 VAC
2	AC In	Other side of AC power supply (if AC power used)	
1	DC GND	Negative side of DC power supply (if DC power used)	Internally, the chassis ground of the Server is connected to this terminal.
2	DC power supply	Positive side of DC power supply (if DC power used)	+12VDC to 30 VDC

## RS-485 Receiver Biasing

Vlinx ESR90xW wireless serial servers provide built-in receiver biasing on RS-485 ports (includes the 902W485 port, 902W Port 2 and 904W Ports 2 and 4). The Data(+) line is pulled up to 3.3V supply using a 4.7 k $\Omega$  resistor and the Data(-) line is pulled down to ground, also using a 4.7 k $\Omega$  resistor.

## RS-422/485 Terminating

If a terminating resistor is deemed necessary, for RS-422 operation typically a 120  $\Omega$  resistor would be connected across the Receive Data(+) and Receive Data(-) lines. For RS-485 operation the resistor would be connected across the Data(+) and Data(-) lines.

For more information on Receiver Biasing and RS-422/485 Terminating access the B&B Electronics RS-422/485 Application Note available at [www.bb-elec.com](http://www.bb-elec.com)

## Connections for Server Configuration

Vlinx ESR90xW Wireless Serial Servers can be configured via:

- A wired connection to a RJ-45 Ethernet connector on the ESR90xW front panel.
- The wireless network

The wired connection is recommended for configuration, especially when configuring wireless settings, to ensure communication is not lost while changing settings.



Figure 6. Wired Connection for Configuration

For wireless configuration, or for typical infrastructure mode operation, the Vlinx ESR90xW communicates with a wireless access point, which is connected to a PC via a wired network.

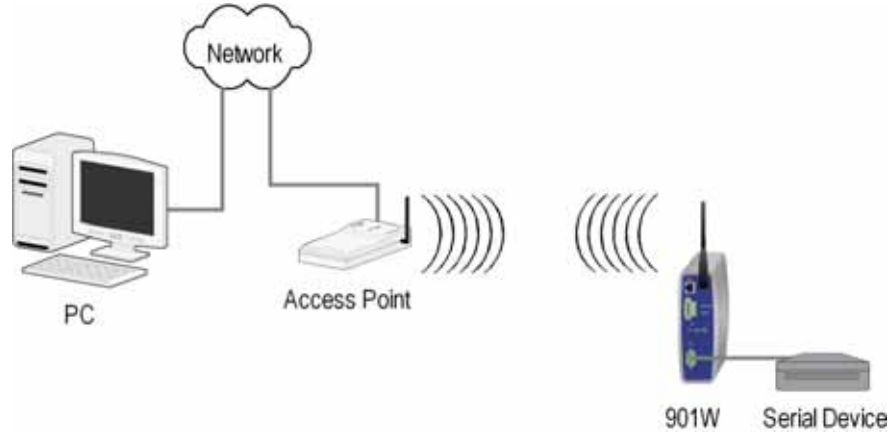

Figure 7. Connection via the Wireless LAN

## Other Hardware Connections

Serial tunneling can occur between two ESR90xW serial servers communicating with individual access points and across a wired network.

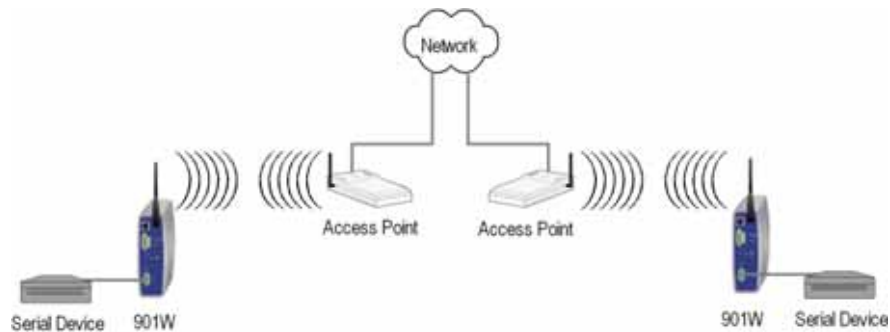

Figure 8. Serial Tunneling via Infrastructure

## Chapter 4: Device Configuration via Web Console

The **Web Console** can be used to configure your Vlinx ESR90xW Wireless Serial Server from any web browser software (such as Internet Explorer, Mozilla Firefox or Netscape). Server properties can be set up using six browser pages: **Main**, **Serial**, **Network**, **Wireless**, **User** and **Status**.

### Accessing the Web Browser

In your browser, type the IP Address of the serial server into the address field at the top of the window and press the **Enter key**. The following window appears.

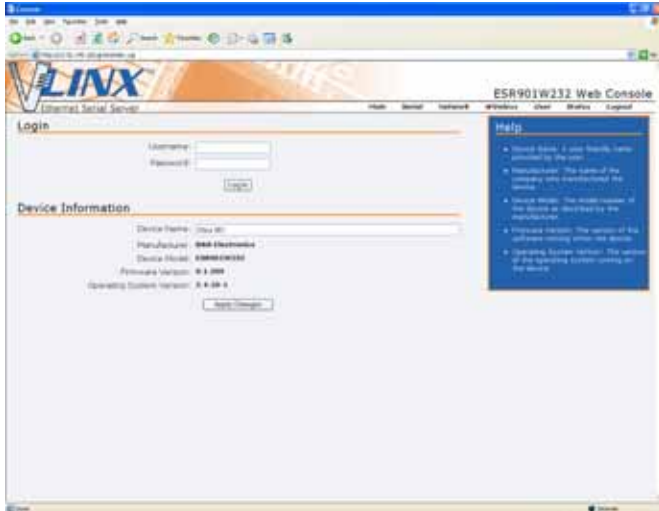

Figure 9. The Web Console Main Page

Enter your **Username** and **Password** to Login. The default username is “Administrator” with no password. After you have logged in you will be able to navigate through the web console pages and change properties as required using the mouse and keyboard.

You can change the **Device Name** of the serial server by typing in a different name

For changes to take effect on this or any other Web Console page, you must click the **Apply** button before navigating away from the page.

### Configuring the Serial Port

To configure the serial server serial port parameters to match the serial device connected to the serial server’s port click **Serial** on the Web Console banner. The **Serial Configuration** page appears. In the **Serial Configuration** page you can select each serial port on the serial server and view or change its parameters.

Figure 10. The Web Console Serial Configuration Page

Select the port to be configured from the **Port** dropdown list. The selections available in the **Interface Type** dropdown will change depending on the capabilities of the selected port. Select the communications parameters based on the requirements of the serial device to be connected to the serial server.

### Configuring Communications Modes and Protocols

To configure serial server communications modes and protocols, click the **Advanced** button on the Serial Configuration page. The **Advanced Serial Configuration** page appears. On this page you can configure:

- **Connection Mode** (TCP or UDP)

- **Connection Protocol** (RAW Client, RAW Server, Virtual COM Port Server, RFC2217 Client)
- **Server (Remote) IP Address**
- **Server (Remote) Port**
- **Local Port**
- **Send Serial Data to Ethernet...** conditions

For explanations of these configuration parameters see *Adjusting the behavior of device communication ports.*

## Configuring Network Properties

To view or change network properties, click **Network** on the Web Console banner. The **Device Network Settings** appears. This page contains the Ethernet settings for the wired Configuration Port and the wireless serial server. If you are configuring the ESR90xW via the hardwired **Configuration Port** select **Wired Port** in the dropdown list box. To configure via the wireless network, select **Wireless** in the dropdown list box.

You can choose between dynamic or static IP addressing and view or set up static addressing parameters.

Figure 11. The Web Console Device Network Settings Page

## Configuring Wireless Properties

To view or change wireless properties, click **Wireless** on the Web Console banner. The **Wireless Interface Configuration** page appears.

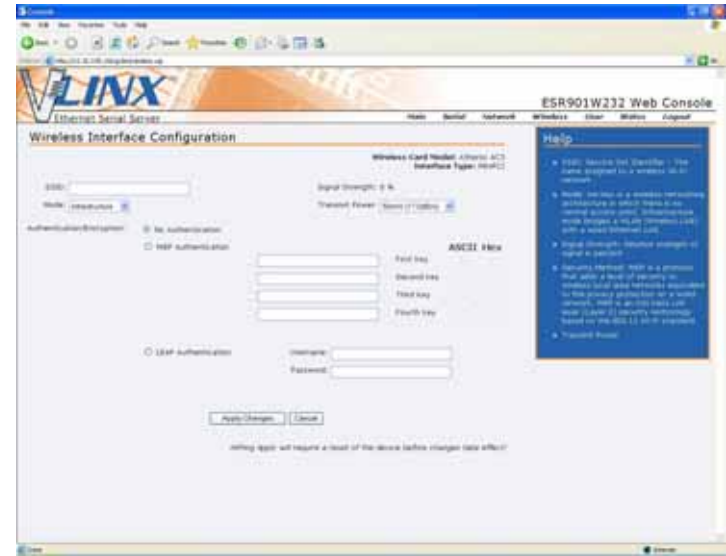

Figure 12. The Vlinx Web Console Wireless Interface Configuration Page

On this page you can specify the **SSID**, or name of the network you want to connect to. Several other text boxes display useful information about the devices wireless network configuration:

- **Wireless Output Power**
- **Security Method**
  - **WEP**
  - **LEAP**

## Managing Users Accounts

As administrator, you can configure multiple user accounts, setting up rights for each user. **User Accounts** can be added and removed, and user details viewed in the **Users** page. User Details (rights) include: **Manage User Accounts, Modify Device Network Settings, Modify Device Serial Port Settings, Manage Log, Update Device Firmware** and **Reset Device**.

To view or change user properties, click **User** on the Web Console banner. The following page will appear:

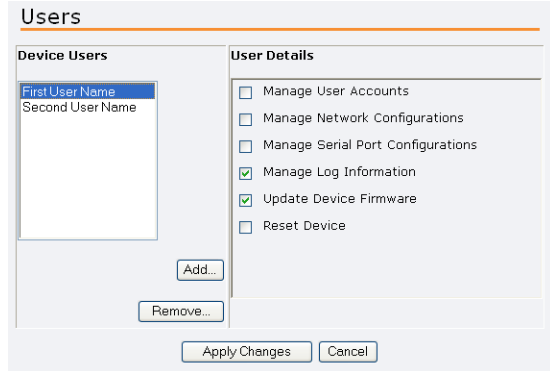

Figure 13. The Vlinx Web Console Users Page

## Using Device Status Information

To view or change device status properties, click **Status** on the Web Console banner. The following page will appear:

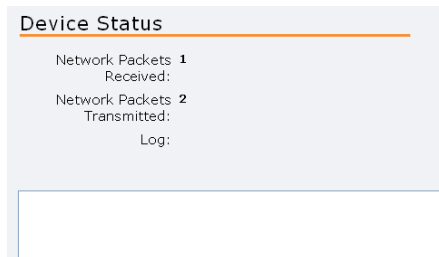

Figure 14. The Vlinx Web Console Status Page

## Chapter 5: Adjusting the Behavior of Device Communication Ports

There is a significant difference between serial and Ethernet data communications. Data that comes in through the Ethernet is presented to the device in the form of very distinct packets. On the other hand without information about the format of the data coming in through the serial port the device may not know at what point to package up the data and hand it off to the Ethernet network. It is for this reason that the ESR90xW series of devices allow you to define when the device converts serial stream data into Ethernet packets. The following examples are provided to illustrate the power behind these options:

**Configuration #1:** The ESR90xW is connected to a device used to monitor air temperature. Software that interfaces with this hardware polls the device for the current status once a minute. This data is returned in the form of a single byte containing the temperature in Celsius.

**Configuration #2:** This ESR90xW is connected to a machine is connected to an ATM machine. When a customer starts a transaction with the ATM a large burst of serial data is passed onto the central bank.

Obviously in both of the configurations the data is critical and needs to be passed over the network in the quickest manner possible. For configuration #1 the best behavior for the device would be to send the incoming byte of temperature information out over the network as soon as it comes in. On the other hand if the device acted the same way for the second configuration it would flood the network with all of the Ethernet overhead. In this case the device would be better to wait for a moment and send a full Ethernet packet rather than a packet for each byte of data.

There are a number of different conditions that your ESR90xW can be configured to watch for when dealing with the data coming in through it's serial communication port(s).

- Polling Strings
- Timeouts
- Data Quantities

## Polling Strings

Polling strings are used when you want the ESR90xW to look for a specific data pattern before taking the data in it's serial buffer and creating an Ethernet packet with it. Polling strings can be configured to monitor not only the serial traffic but the Ethernet traffic as well.

## Timeouts

Polling strings are used when you want the ESR90xW to look for a specific data pattern before taking the data in its serial buffer and creating an Ethernet packet with it.

There are two different types of timeouts. Total Message and Inter-character timeouts. A Total Message timeout counter starts when the first byte is received. Once the specified amount of time has elapsed since this initial byte the trigger is fired and the device will transmit the buffered data.

The second type of timeout is an Inter-character timeout. This is used to trigger after a defined amount of inactivity.

## Data Quantities

In addition to the two previously mentioned methods of Ethernet packet transmission triggers you can also setup a specific data amount that the device will wait for before acting on the incoming data.

## Using Multiple Conditions

You can use the data trigger conditions individually or it is also possible to use them in combination with each other. When more than one condition is specified they are treated as a “logical AND”. This means that if any of the conditions specified is true then the data buffer is transmitted.

## Chapter 6: Device Discovery and Virtual COM Ports

### Device Detection Utility

To find devices on a wireless network, run the Device Detection Utility. This program will be installed in the start menu at B&B Electronics\Tools.

To use, click “Scan For Devices”. The software will send a broadcast and all devices on that subnet will be displayed in the list. The device will be displayed with a friendly name and the IP Address that it was found on.

A typical scan would look something like this:

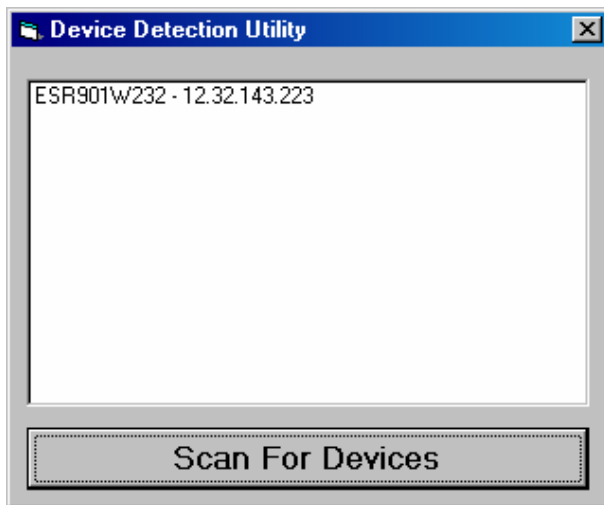

After completing a network scan, use the IP Address to browse to the Web Server to configure the device.

## VCOM Port Setup

To install and manage Virtual COM ports, Serial IP software will be provided. The software will be installed in the start menu at Serial-IP. To run the setup software, choose Control Panel and this screen will be displayed:

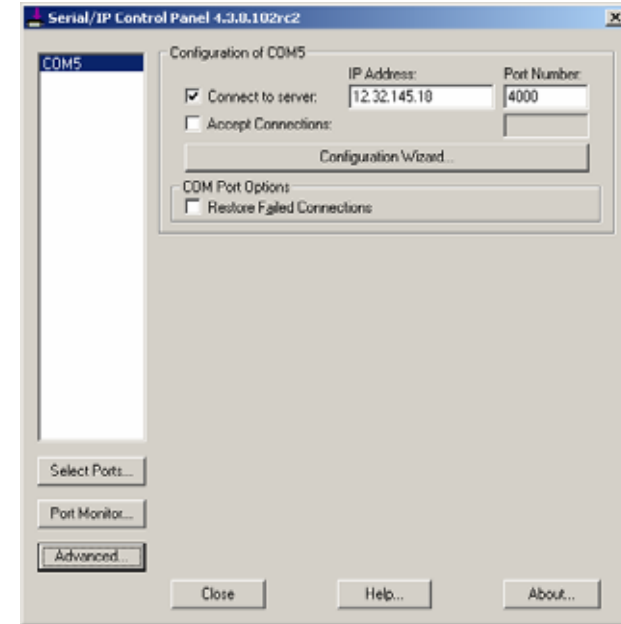

To setup and assign a port, follow these steps:

1. Click “Select Ports” to assign a VCOM
2. Check “Connect to server”
3. Assign IP Address and Port number of device
4. Click “Configuration Wizard”
5. Click “Start”
6. If Configuration Wizard completes successfully, click “Use Settings”
7. Close Serial IP Control Panel

## Appendix A: Vlinx ESR90xW Technical Data

### Product Specifications

Serial Server Model:	Vlinx ESR901W232, Vlinx ESR901W485, Vlinx ESR902W or Vlinx ESR904W
Manual:	Paper copy of this manual, PDF available
Dimensions	6.85 x 5.72 x 2.27 in (17.4 x 14.5 x 5.77 cm)
Power Supply Voltage Requirements:	12V to 30 VDC or 24VAC
Power Consumption:	12W max, on air
Operating Temperature:	0 to 60 °C (32 to 140 °F)
Storage Temperature:	-40 to 85 °C (-40 to 185 °F)
Humidity:	5% to 98% R.H. non-condensing
Approvals:	CE, FCC (using the supplied antenna)
Serial Port Activity Indicator:	Red LED
Link/Activity Indicator:	Red LED
Port Indicator:	Red LED
Set Up Connector:	Single RJ-45 female (auto configuring)
Serial Connector(s):	Vlinx ESR901W232: one 9 pin D-type male (DB-9M) Vlinx ESR901W485 one removable five terminal screw-type terminal block Vlinx ESR902W: Two 9 pin D-type male (DB-9M) Vlinx ESR904W: Four 9 pin D-type male (DB-9M)
Power Supply:	(AC or DC) Removable four terminal screw-type terminal block
RS-232 Interface Lines Supported:	TXD, RXD, RTS, CTS, DTR, DSR, DCD, RI, GND
RS-422 Interface Lines Supported:	TXDB(+), TXDA(-), RXDB(+), RXDA(-) and GND
RS-485 Interface Lines Supported:	Data B (+), Data A (-) and GND
Serial Data Rates:	110, 300, 600, 1200, 2400, 4800, 9600, 14400, 19200, 28800, 38400, 57600, 115200, 230400 bps

Parity:	None, Even, Odd, Mark, Space
Data Bits:	5, 6, 7 or 8
Stop Bits:	1, 1.5 or 2
Set-up Options:	Vlinx Web Console Configuration
Configuration Modes:	Direct TCP Server, Client Virtual COM Port Connection Pair Mode
Configuration Port:	Ethernet RJ-45, Auto-MDX
Wireless Network Interface:	2.4 GHz IEEE 802.11g DSSS
Wireless Data Rates:	54, 48, 36, 24, 18, 12, 9, 6, 11, 5.5, 2, 1 Mbps
RF Power:	+15 dBm Nominal (without antenna gain)
Security:	WEP standard encryption, 64/128 bit, administration/configuration password protection
Antenna:	Omni-directional antenna included, reverse SMA connector
Protocols:	TCP, IP, ARP, DHCP, HTTP, UDP, ICMP
Stability & Troubleshooting Features:	Internal device application logging, Fault logging Hardware watchdog timer LEDs indicators for Power, Signal strength, LAN-link, Data
Advanced Data Management:	Buffer level triggering Serial and network delimiter triggering Serial line status triggering Total message timeout Inter-character message timeout
Accessories:	Lightning arrester Panel mount bracket
Serial Memory:	1K byte per port
Network Memory:	1K byte

## Default Server Properties

Server Name	Vlinx ESR901W232 or Vlinx ESR901W485 or Vlinx ESR902W or Vlinx ESR904W
Serial Number:	(printed on bottom of unit)
Password:	Blank
DHCP:	Disable
IP Address:	192.168.0.200
Net Mask:	255.255.255.0
Gateway:	192.168.0.254
MAC Address:	Fixed – see bottom label
Version&Date:	current firmware version number & date
Serial server port:	1
Baud Rate:	9600
Data/Stop:	8-1
Parity:	None
Flow Control:	None
TCP/UDP Protocol:	TCP
Serial timeout:	0 seconds
TCP alive timeout:	0 minutes
Connection Mode:	Server
TCP/UDP port:	Vlinx ESR901W/902/904 Port 1: 4000 Vlinx ESR902W/904 Port 2: 4001 Vlinx ESR904W Port 3: 4002 Vlinx ESR904W Port 4: 4003
Serial port mode:	Vlinx 901W/902/904 (all ports): RS-232
Max connection:	1
Remote IP Address:	255.255.255.255

## Vlinx ESR90xW Dimensional Diagrams

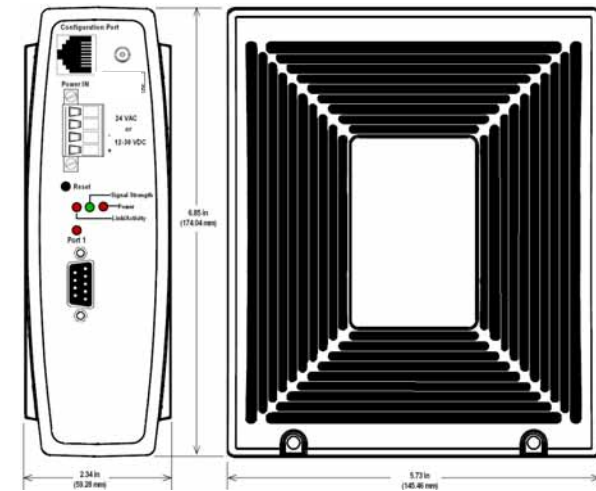

Figure 15. Dimensional Diagram of the Vlinx ESR901W232

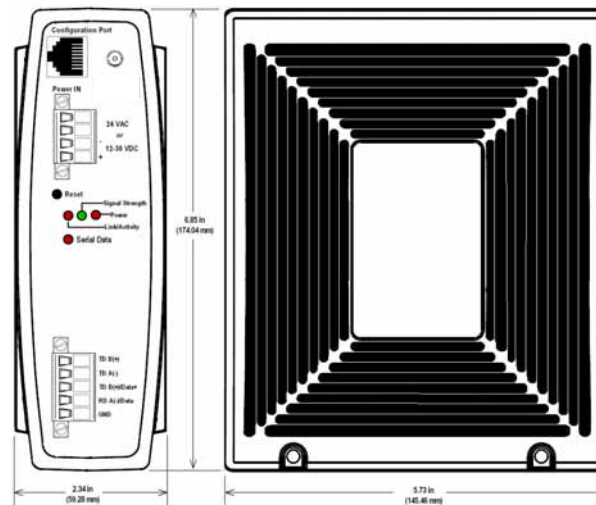

Figure 16. Dimensional Diagram of the Vlinx ESR901W485

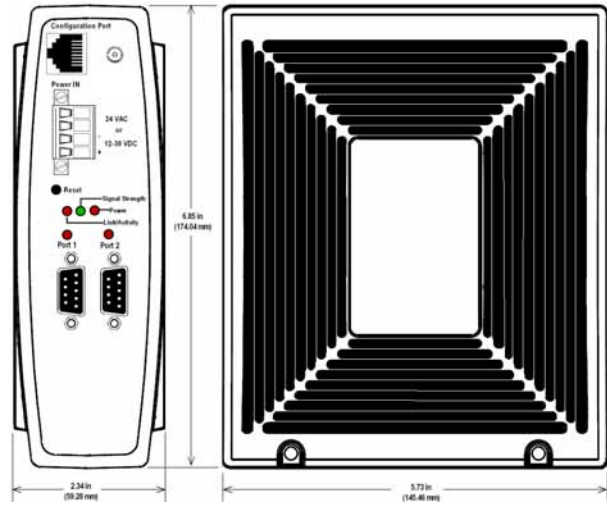

Figure 17. Dimensional Diagram of the Vlinx 902W

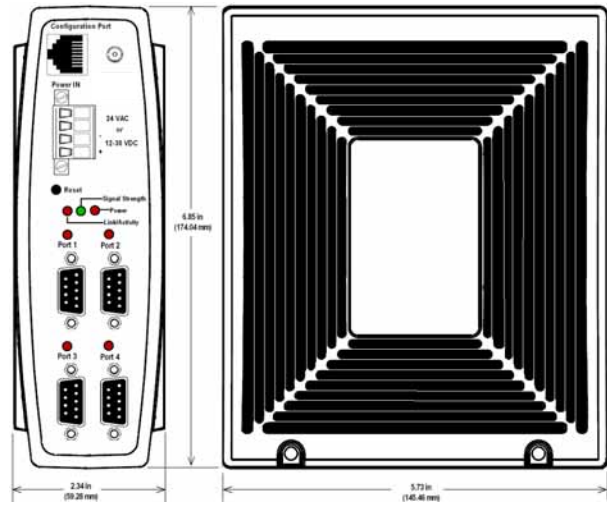

Figure 18. Dimensional Diagram of the Vlinx 904W

## Appendix B: RS-232/422/485 Connections

### DB-9 Pin-outs for RS-232 and RS-232/422/485 Connections

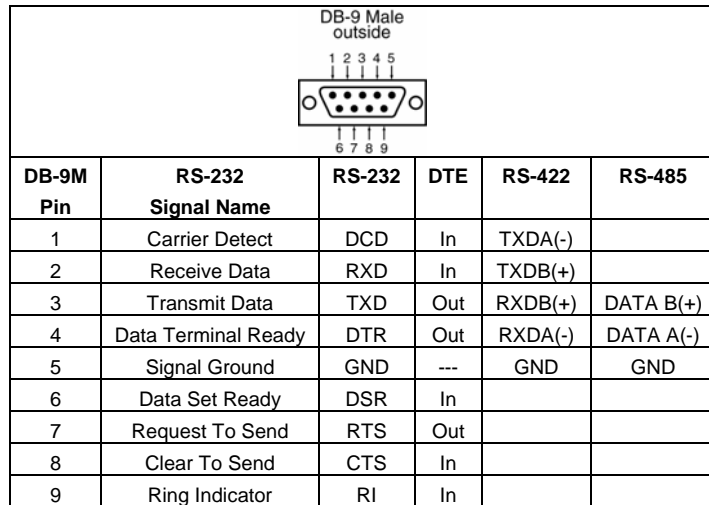

Figure 19. DB-9 Pin-outs for RS-232/422/485

### Terminal Block Pin-out for RS-422 and RS-485 (Vlinx ESR901W485 only)

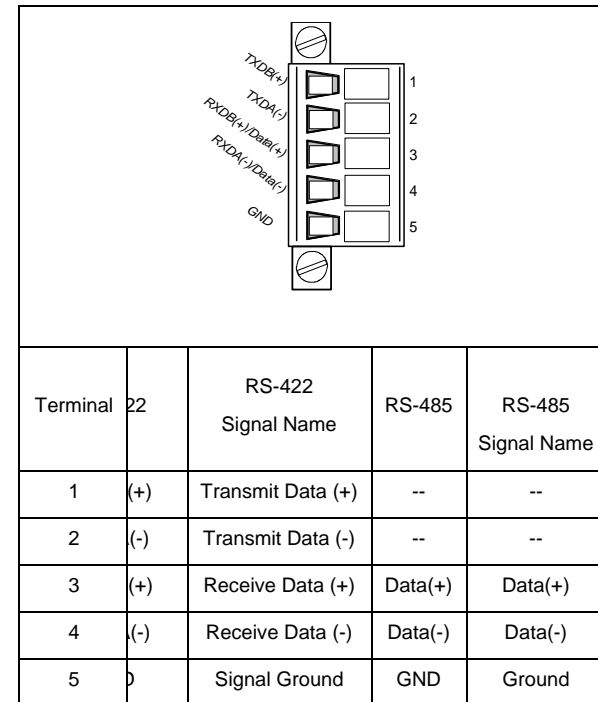

Figure 20. Terminal Block Pin-out for Vlinx ESR901W485 Serial Connection

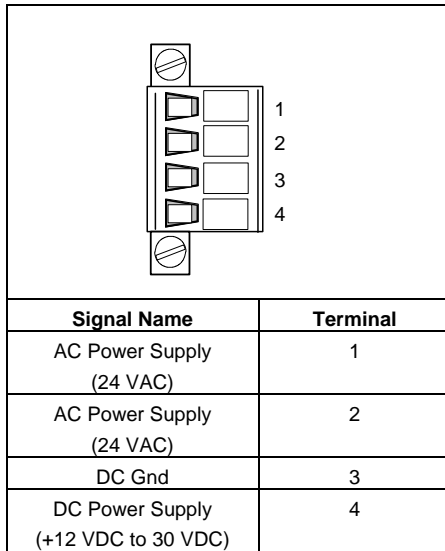

Figure 21. Terminal Block Pin-out for Vlinx ESR90xW Power Supply Connection

## Appendix C: Configuration Port Connections

### RJ-45 Pin-out for Configuration Port Connection

The Configuration Port on the Vlinx ESR90xW Wireless Serial Servers is wired as a standard Ethernet connector. However, this port is intended for direct connection to a PC for configuration purposes only and is not to be connected to a network.

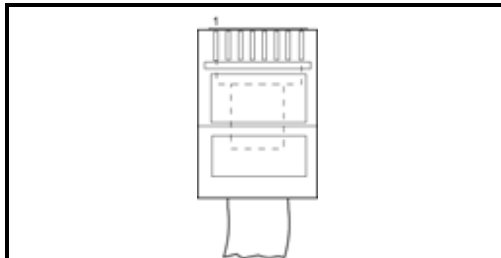

A standard Ethernet cable can be used to connect the PC to the Configuration Port.



RJ-45 Pin	Signal	Wire Color	RJ-45 Pin
1	TX+	White-Green	1
2	TX-	Green	2
3	RX+	White-Orange	3
4	Not used	Blue	4
5	Not used	White-Blue	5
6	RX-	Orange	6
7	Not used	White-Brown	7
8	Not used	Brown	8

Figure 22. Pin-out for a Standard Ethernet Cable

## Declaration of Conformity

DECLARATION OF CONFORMITY	
Manufacturer's Name:	B&B Electronics Manufacturing Company
Manufacturer's Address:	P.O. Box 1040 707Dayton Road Ottawa, IL 61350 USA
Model Numbers:	ESR901W232, ESR901W485, ESR902W, ESR904W
Description:	Wireless Serial Servers
Type:	Light industrial ITE equipment
Application of Council Directive:	89/336-EEC
Standards:	EN 55022 EN 61000-6-1 EN 61000 (-4-1, -4-3, -4-4, -4-5, -4-6, -4-8, -4-11)
	
Robert M. Paratore, Director of Engineering	
	



### International Headquarters

B&B Electronics Mfg. Co. Inc.  
707 Dayton Road  
Ottawa, IL 61350 USA

Phone (815) 433-5100 -- General Fax (815) 433-5105

Website: [www.bb-elec.com](http://www.bb-elec.com)

Sales e-mail: [orders@bb-elec.com](mailto:orders@bb-elec.com) -- Fax (815) 433-5109

Technical Support e-mail: [support@bb.elec.com](mailto:support@bb.elec.com) -- Fax (815) 433-5104

### European Headquarters

B&B Electronics Ltd.  
Westlink Commercial Park  
Oranmore, Co. Galway, Ireland

Phone +353 91-792444 -- Fax +353 91-792445

Website: [www.bb-europe.com](http://www.bb-europe.com)

Sales e-mail: [sales@bb-europe.com](mailto:sales@bb-europe.com)

Technical Support e-mail: [support@bb-europe.com](mailto:support@bb-europe.com)

© B&B Electronics – November 2005